

OPERATING MANUAL

ba75998e05 03/2015



P 700 IQ Analyzer

MEASURING SYSTEM FOR ONLINE DETERMINATION OF ORTHOPHOSHATE IN AQUEOUS
SAMPLES



a xylem brand

Contents

1	Overview	
1.1	How to use this component operating manual	7
1.2	Metrological basics	8
1.3	Product description	9
1.3.1	Overview	9
1.3.2	Photometer unit	11
1.3.3	Status LED	13
1.3.4	Instrument options	13
1.3.5	Return tube (accessory)	15
1.3.6	Sample filtration device (accessory)	15
1.4	Name plates	16
2	Safety	
2.1	Safety information	17
2.1.1	Hazard warnings in this operating manual	17
2.1.2	Safety information on the product	17
2.1.3	Labels on the chemical containers	17
2.1.4	Safety datasheets of the chemicals	18
2.2	Safe operation	18
2.2.1	Authorized use	18
2.2.2	Requirements for safe operation	18
2.2.3	Unauthorized use	18
2.3	Personal protective equipment (PPE)	19
3	Commissioning	
3.1	IQ SENSOR NET system requirements	21
3.2	Scope of delivery	21
3.2.1	Scope of delivery of the P 700 IQ	21
3.2.2	Accessories required in addition	22
3.3	Installation	23
3.3.1	Safety requirements on the electrical installation	23
3.3.2	General installation instructions	24
3.3.3	Installing the housing	24
3.3.3.1	Installation on the SM stand mount	25
3.3.3.2	Installation on a rail	30
3.3.3.3	Installation on a wall	34
3.3.4	Installing the FM filter membrane module and the M 1.5 attachment for filtration	35

3.3.5	Inserting the connections into the housing.	36
3.3.6	Connecting the lines.	38
3.3.6.1	Connecting the IQ SENSOR NET cable to the MIQ/WCA 232.	39
3.3.6.2	Connecting the power line and heat tracing lines	41
3.3.6.3	Connecting the liquid containers	43
3.4	Initial commissioning	45
4	Measuring / Operation	
4.1	Measuring operation.	49
4.1.1	Determination of measured values	49
4.1.2	Starting the measuring operation.	49
4.1.3	Measuring	51
4.1.4	Settings for the P 700 IQ	51
4.2	Calibration	54
4.2.1	Overview	54
4.2.2	1-point calibration.	55
4.2.3	2-point calibration.	58
4.2.4	Calibration history	62
4.2.5	Reactivating the last valid calibration.	62
5	Maintenance and cleaning	
5.1	Hazard warnings	65
5.2	Consumables, accessories, replacement parts	65
5.3	Maintenance and cleaning activities (general steps)	68
5.3.1	General information	68
5.3.2	Calibration and service menu (<i>SERVICE</i> menu).	69
5.3.3	Maintenance and cleaning work on the closed P 700 IQ.	72
5.3.4	Maintenance and cleaning work on the open P 700 IQ	74
5.4	Carrying out the maintenance and cleaning activities	77
5.4.1	Changing the liquid containers.	77
5.4.2	Checking the climate kit (if available).	78
5.4.3	Changing the filter mats	80
5.4.4	Changing the tube set (T SET)	81
5.4.5	Changing the pump tube of the peristaltic pump	85
5.4.6	Cleaning the filter membrane.	90
5.4.6.1	Mechanical cleaning.	91
5.4.6.2	Chemical cleaning	92
5.4.7	Exchanging the filter membrane	94
5.4.8	Storing a used filter membrane	95
5.4.9	Cleaning the overflow vessel	95
5.4.10	Cleaning the suction tube of the sample filtration	96
5.4.11	Performing a <i>Hydraulic check</i>	99
5.4.12	Performing an <i>LED Check</i>	100

6	What to do if ...	
7	Technical data	
7.1	Measurement characteristics	107
7.2	Application characteristics	107
7.3	General data	108
7.4	Electrical data	112
7.5	Consumption data	113
8	Indexes	
8.1	Explanation of the messages	115
	8.1.1 Error messages	115
	8.1.2 Info messages	117
8.2	Status info	117
9	Appendix	
9.1	Glossary	119

1. Overview

1.1 How to use this component operating manual

Structure of the IQ SENSOR NET operating manual

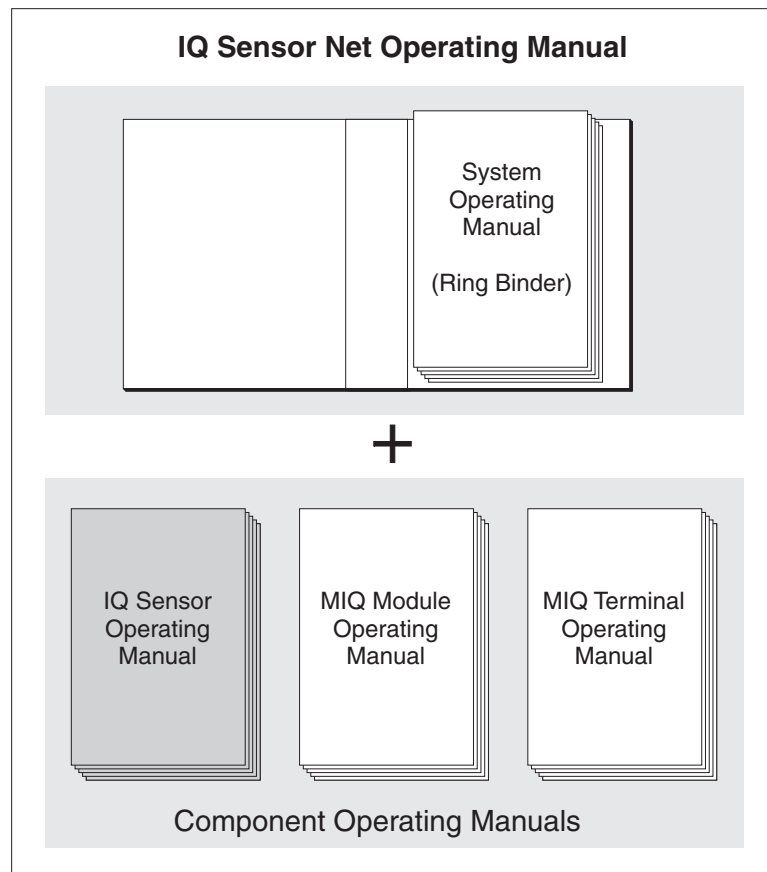

Fig. 1-1: Structure of the IQ SENSOR NET operating manual

The IQ SENSOR NET operating manual has a modular structure like the IQ SENSOR NET system itself. It consists of a system operating manual and the operating manuals of all the components used.

Please file this component operating manual into the ring binder of the system operating manual.

1.2 Metrological basics

Phosphate The salts of the phosphoric acid are called phosphate. With simple phosphoric acid (orthophosphoric acid, H_3PO_4) this is orthophosphate (anion PO_4^{3-}).

Measuring method The P 700 IQ phosphate analyzer measures the concentration of orthophosphate in an aqueous solution with the aid of the vanadate molybdate method (yellow method).

The reagent contains an aqueous solution of ammonium metavanadate NH_4VO_3 and ammonium heptamolybdate $(\text{NH}_4)_6\text{Mo}_7\text{O}_{24}$ with an addition of sulfuric acid H_2SO_4 . In an acidic environment, the chemical reaction takes place according to the following molecular formula:

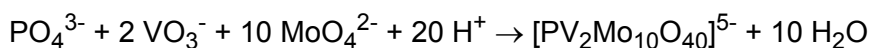

The originally pale yellow reagent will turn a deep yellow. The change of absorbance is photometrically measured at a wavelength of 420 nm. From this, the concentration of orthophosphate is calculated.

Citation forms Phosphate concentration is quoted in milligrams per liter (mg/l). This value can either refer to all orthophosphate ions or only to the phosphorus atom included. The values can be converted as follows:

- 1 mg P = 3.066 mg PO₄
- 1 mg PO₄ = 0.3261 mg P

Concentration values referring to the phosphorus atom are indicated by the addition PO₄-P (citation form).

1.3 Product description

1.3.1 Overview

The P 700 IQ analyzer is designed for online measurements of the orthophosphate concentration (PO₄) in aqueous samples, especially for phosphorus elimination in waste water treatment plants. Measurement takes place photometrically, at adjustable intervals.

Instrument design

Fig. 1-2, 9 shows the mains components of the P 700 IQ.

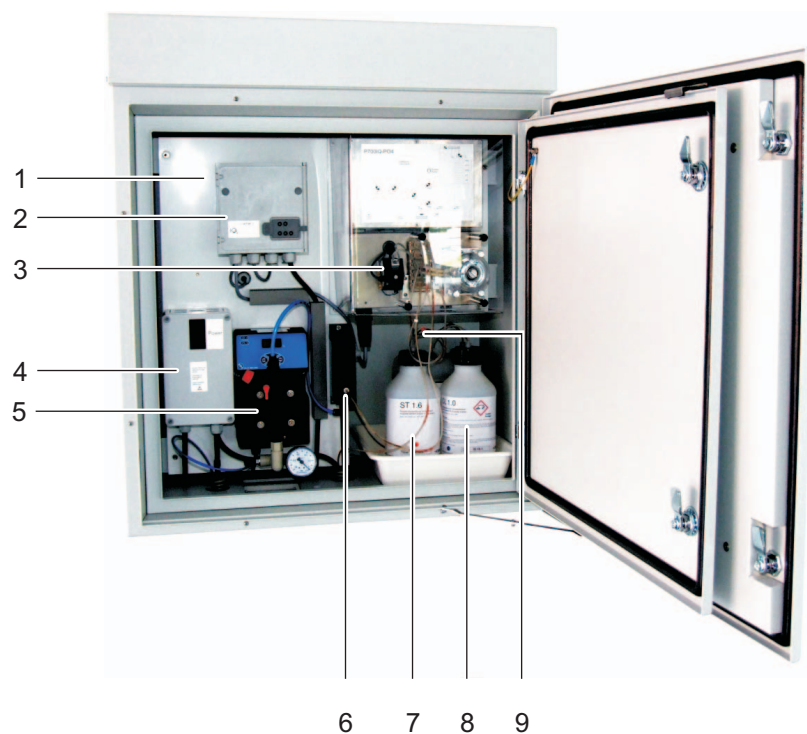

Fig. 1-2: Main components of the P 700 IQ

- 1 Power supply unit for the photometer unit
- 2 IQ SENSOR NET interface MIQ/WCA 232
- 3 Photometer unit P700IQ-PO4
- 4 Power supply box
- 5 Filtration pump (instrument option)
- 6 Overflow vessel
- 7 Cleaning solution
- 8 Standard solution
- 9 Reagent

Power supply and communication

Fig. 1-3, 10 shows the power supply and communication interfaces of the P 700 IQ.

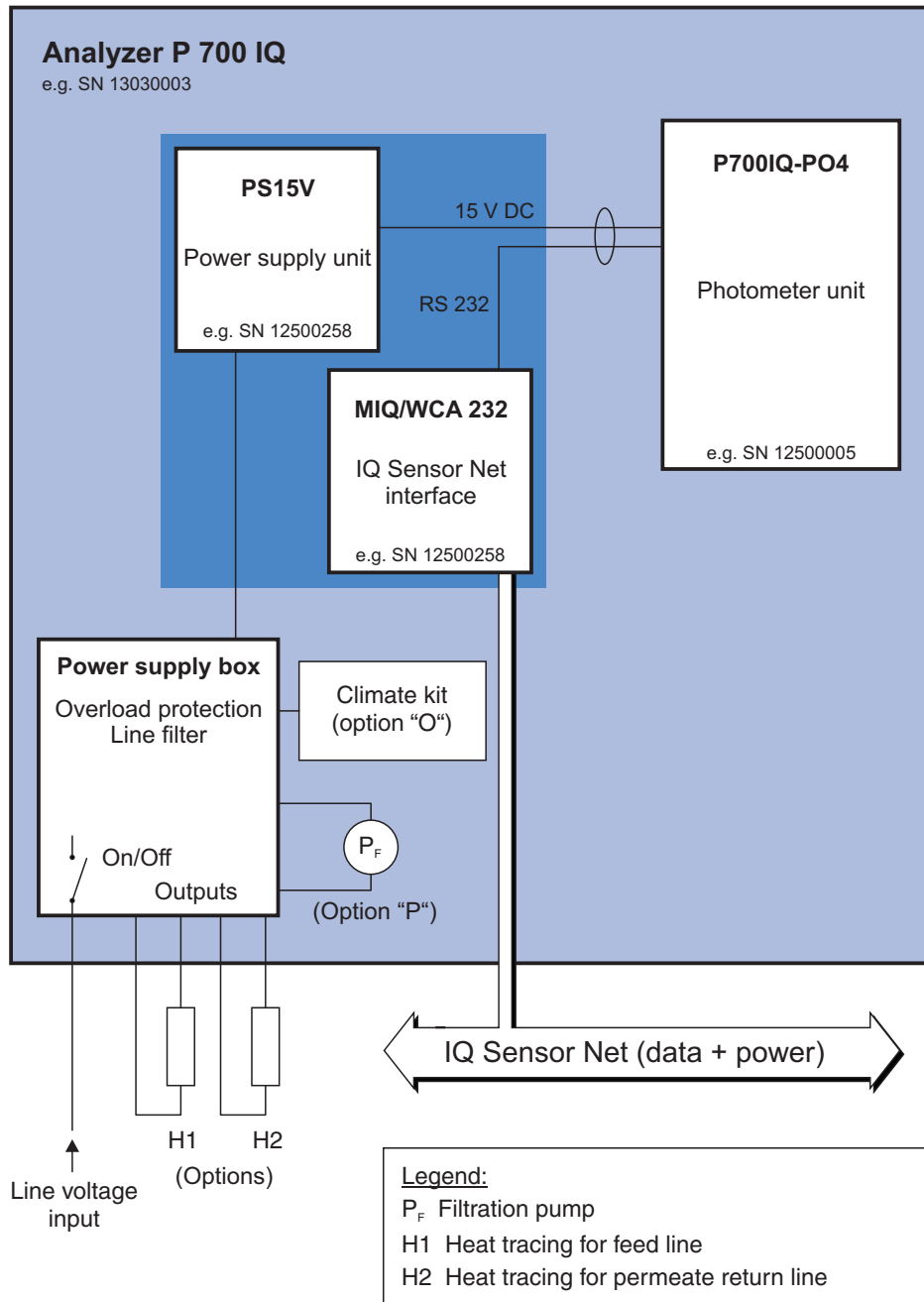

Fig. 1-3: Block diagram P 700 IQ

Operation

The P 700 IQ is operated with a terminal on the IQ SENSOR NET. It is connected to the IQ SENSOR NET through the MIQ/WCA 232 interface. For more ease of use while maintenance activities are being carried out on the open analyzer, a mobile terminal can be docked onto the lid of the MIQ/WCA 232. The MIQ/WCA 232 interface is supplied with power by the IQ SENSOR NET.



Information on IQ SENSOR NET terminals is given in the relevant IQ SENSOR NET system operating manual.

1.3.2 Photometer unit

Fig. 1-4, 11 shows the hydraulic system of the P700IQ-PO4 photometer unit.

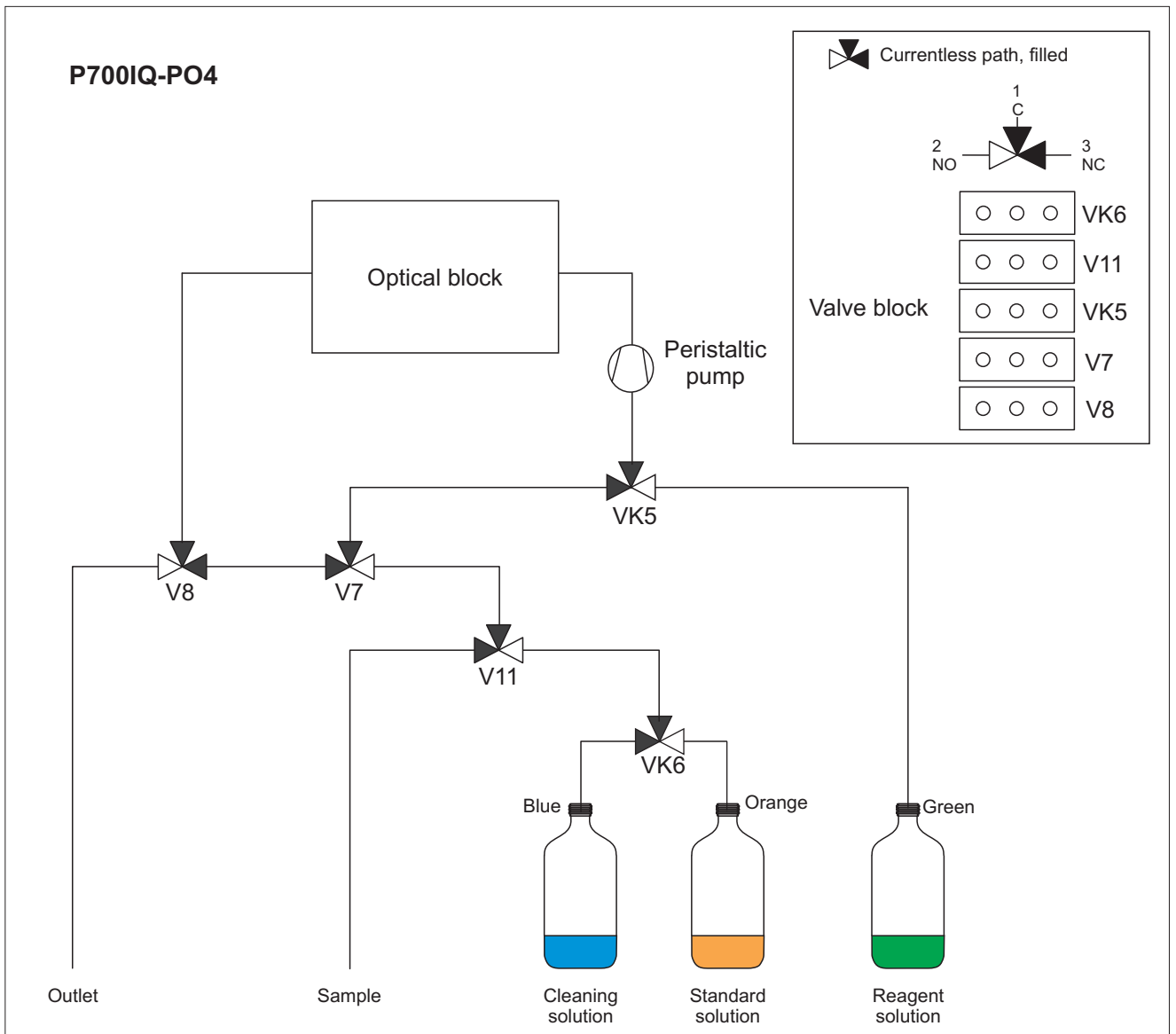

Fig. 1-4: Hydraulic system

Fig. 1-5, 12 shows the photometer unit installed.

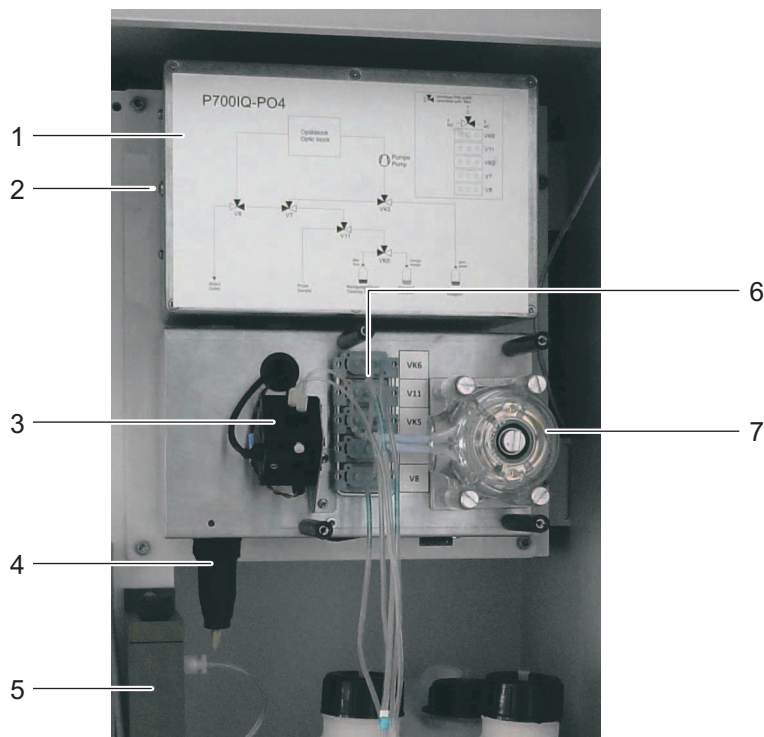

Fig. 1-5: Photometer unit without plastic cover

- 1 Controller housing
- 2 Status LED
- 3 Optical block
- 4 Joint connection cable for supply voltage and communication
- 5 Overflow vessel
- 6 Valve block with inlet and outlet tubes
- 7 Peristaltic pump

How it functions

The photometer unit is supplied with d.c. voltage by the PS15V power pack and operated by a controller (1). It communicates with the IQ SENSOR NET through the MIQ/WCA 232 interface.

The PS15V power supply unit is solely intended for supplying the photometer unit and is not a component of the IQ SENSOR NET.

In conjunction with the peristaltic pump (7), the valve block (6) controls the movement of the liquids (sample, reagent, standard solution, cleaning solution).

The photometer unit draws the sample from the overflow vessel (5). Filtrated sample continuously flows through the overflow vessel. Thus the sample is constantly available and free of air bubbles. The filtration unit (available as an accessory) in conjunction with the filtration pump (instrument option "P") provides an optimally prepared sample.

The absorbance of the reaction mixture is measured in the optical block (3). The optical block has an LED as the light source and photo diodes

as a detector. After the measurement, the liquid is removed from the optical block.

1.3.3 Status LED

The status LED on the controller housing indicates the current operating condition:

LED	Meaning
Off	No power supply
green	The P700IQ-PO4 photometer unit is ready for operation and waiting for the next action.
red	The photometer unit is performing an action.

Tab. 1-1: Conditions of the status LED

1.3.4 Instrument options

The P 700 IQ analyzer is available with different options. The options installed are quoted in the type designation on the name plate:

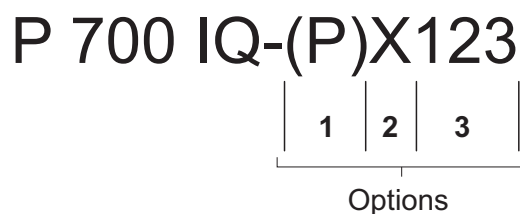

Fig. 1-6: Structure of the type designation

Option	Identification / value	Option
1	P	With filtration pump
	(without)	Without filtration pump
2	I	Without climate kit ("Indoor")
	O	With climate kit ("Outdoor")
3	115	Input voltage 115 V AC
	230	Input voltage 230 V AC

Tab. 1-2: Explanation of the option identifiers in the type designation

Filtration pump (instrument option "P")

The filtration pump is optimally adjusted to the sample filtration available as an accessory.



Fig. 1-7,  14 shows the filtration pump in the P 700 IQ analyzer.



Fig. 1-7: Filtration pump

- 1 Control panel with pump frequency indication
- 2 Intake tube of the sample filtration (accessory, see section 1.3.6,  15)
- 3 Connection tube
- 4 Overflow vessel
- 5 Outlet of the overflow vessel
- 6 Return tube (accessory, see section 1.3.5,  15)
- 7 Manometer

The filtration pump continuously draws sample through the intake tube (2) and pumps it into the overflow vessel (4) through the connection tube (3). The flow rate can be set on the control panel (1). On the intake side, a manometer (7) is installed for low pressure measurement.

For sample preparation, a sample filtration device (available as an accessory) can be connected upstream.

Climate kit (instrument option "O")

The climate kit includes an electrical circulating air heating, two housing ventilators and three temperature regulators. The temperature regulators switch on the heating or ventilators if the temperature is less than +15 °C or more than +40 °C. Thus the analyzer with the door closed is suitable for all-season operation in the open. The climate kit is automatically active when the switch on the power supply box is in the ON position.



Where there is a chance of frost, the intake tube and return tube must be provided with a heat tracing.

1.3.5 Return tube (accessory)

The return tube directs out of the analyzer housing the overflowing sample from the overflow vessel and the waste solution from the photometer unit. Return tubes with heat tracing are available for frost protection.



Order information referring to accessories is given in chapter 5.2 Consumables, accessories, replacement parts, 65.

1.3.6 Sample filtration device (accessory)

To separate the particles in the sample, the pre-mounted FM filter membrane module is available as an accessory. It is connected to the analyzer with an intake line. The filtered sample is drawn by the filtration pump in the analyzer (instrument option "P").

The pre-mounted FM filter membrane module (821973) comprises a dividable PVC housing (FM Case, 821973) and a double-sided filter membrane (Membrane insert, 1x consisting of filter, 821972). With the aid of the M 1.5 attachment for filtration, the FM filter membrane module can be immersed in the measuring medium and can be adjusted in height. To clean the filter membrane, the filter membrane module can be pulled out along a guide rail with a chain.

The intake line consists of an intake tube in a robust sleeve tube. Intake lines are available in different lengths and with auxiliary heating to protect against frost (depending on the line voltage).

Fig. 1-8, 15 shows an application example in a sedimentation tank.

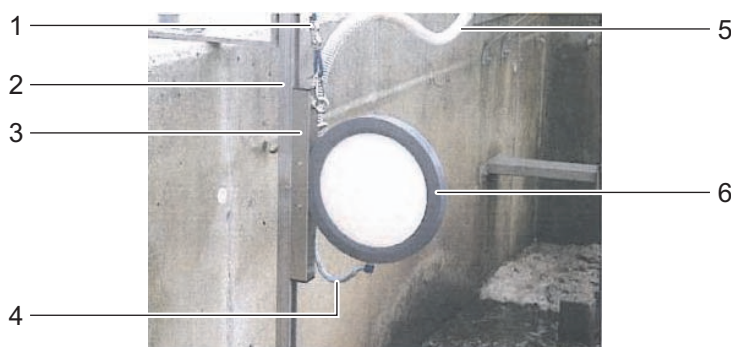

Fig. 1-8: Sample filtration device (installed)

- 1 Chain (scope of delivery: Attachment for filtration M 1.5)
- 2 Guide rail (scope of delivery: Attachment for filtration M 1.5)
- 3 Height adjustable slide (scope of delivery: Suction line)
- 4 Intake line (scope of delivery: Suction line)
- 5 Sleeve tube (scope of delivery: Suction line)
- 6 Filter membrane module FM with membrane insert



Order information referring to accessories is given in chapter 5.2 Consumables, accessories, replacement parts, 65.

1.4 Name plates

The following components have name plates:

Component	Place of the name plate
Total analyzer	In the right-hand bottom edge on the inside of the housing door
IQ SENSOR NET interface MIQ/WCA 232	On the right side of the MIQ/WCA 232
Photometer unit P700IQ-PO4	On the left side of the controller housing of the photometer unit
Power supply unit for the PS15V photometer unit	On the right side of the PS15V

Tab. 1-3: Name plates





Keep the series numbers on the name plates ready for any service requests.

2. Safety

2.1 Safety information

2.1.1 Hazard warnings in this operating manual

The hazard warnings are defined for the following levels of danger:

	<p style="text-align: center;">⚠ WARNING</p> <p>WARNING indicates a possibly dangerous situation that can cause death or serious injury if the safety instruction is not followed.</p>
	<p style="text-align: center;">⚠ CAUTION</p> <p>CAUTION indicates a possibly dangerous situation that can cause slight or medium injury if the safety instruction is not followed.</p>
	<p style="text-align: center;">ATTENTION</p> <p>ATTENTION indicates a situation where goods might be damaged if the actions mentioned are not taken.</p>

2.1.2 Safety information on the product

Note all labels, information signs and safety symbols on the product.

2.1.3 Labels on the chemical containers

Note the labeling on the chemical containers, especially the hazard and safety information.

2.1.4 Safety datasheets of the chemicals

Safety datasheets provide security relevant information on hazardous materials and mixtures. Carefully read the safety datasheets and follow all instructions. We recommend storing all datasheets in one folder.

2.2 Safe operation

2.2.1 Authorized use

The authorized use of the P 700 IQ phosphate analyzer comprises its use as a sensor in the IQ SENSOR NET. Only the operation and running of the analyzer according to the instructions and technical specifications given in this operating manual is authorized (see chapter 7. Technical data,  107). Any other use is considered unauthorized.

2.2.2 Requirements for safe operation

Note the following points for safe operation:

- The product may only be operated according to the authorized use specified above.
- The product may only be supplied with power by the energy sources mentioned in this operating manual.
- The product may only be operated under the environmental conditions mentioned in this operating manual.
- The product or its components may only be opened if this is required for installation and maintenance work and described in the operating manual.

2.2.3 Unauthorized use



The product must not be put into operation if:

- it is visibly damaged (e.g. after being transported)
- it was stored under adverse conditions for a lengthy period of time (storing conditions, see chapter 7 Technical data)

2.3 Personal protective equipment (PPE)

The PPE includes clothing and other equipment that is used to protect you against risks at your place of work. You must always wear your PPE while doing dangerous jobs to avoid injury or damage to your health.

The following table shows the PPE that is required while dealing with dangerous chemicals, e.g. when exchanging the chemical containers. More information is given on the label of the chemical containers and the relevant safety datasheets.

Personal protective equipment	Typical examples
Protective clothing with long sleeves	
Protective goggles	
Chemical resistant gloves	

Tab. 2-1: Personal protective equipment



It is the duty of the operator to provide all users with the required PPE. The PPE must fulfill the national standards and laws.

3. Commissioning

3.1 IQ SENSOR NET system requirements

Software versions of the controller and terminal components

The operation of the P 700 IQ requires the following software versions in the IQ SENSOR NET:

MIQ/MC2	Controller software:	Version 3.39 or higher
MIQ/TC 2020 XT	Terminal software:	Version 3.39 or higher

3.2 Scope of delivery

3.2.1 Scope of delivery of the P 700 IQ

The following parts are included in the scope of delivery of the P 700 IQ:

- Housing with mounted and wired installations including instrument options
- Key for outer housing door
- Switch cabinet key for interior door
- Screwdriver for MIQ/WCA 232
- Mounting aid for pump hose
- Chemicals tray
- Lid set for chemicals
- Operating manual

Check that the scope of delivery is complete before starting the installation.



The power line is not included in the scope of delivery.

3.2.2 Accessories required in addition

Depending on the application, the following additional accessories are required or recommended for operation. We explicitly recommend using original WTW accessories:

Mounting accessories

Ensure the safe fastening at the mounting location. The following variants are available:

- Rail mount RM
- Wall mount WM
- Stand mount SM

Chemicals

- Reagent solution RE 2.5
- Cleaning solution CL 1.0
- Standard solutions ST ... (depending on measuring range and calibration procedures)

Sample preparation (filtration)

- Filter membrane module FM
- Attachment for filtration M 1.5 for filter membrane module FM, also available with extension M-EXT 1.5
- Suction line SL ... (different lengths up to 20 m, with and without heat tracing)
- Return tube RL ... (different lengths up to 20 m, with and without heat tracing)



Order information referring to accessories is given in chapter 5.2 Consumables, accessories, replacement parts, 65.

3.3 Installation

3.3.1 Safety requirements on the electrical installation

Electrical equipment (e.g. motors, contactors, cables, lines, relays) must meet the following requirements:

- Conformity with national regulations (e.g. NEC, VDE and IEC)
- Suitability for the electrical conditions at the installation site
 - Maximum operating voltage
 - Maximum operating current
- Suitability for the environmental conditions at the installation site
 - Temperature resistance (minimum and maximum temperature)
 - Stability against UV light when used outdoors
 - Protection against water and dust (Nema or IP protection class).
- Suitable fusing of the electrical circuit
 - Overcurrent fuses (in accordance with the technical data of the device input or output)
 - Overvoltage class II surge limiters
- Suitable disconnecting device (e.g. switch or circuit breaker) for the mains supply of permanently mounted equipment with separate mains connection,
 - conforming to
 - IEC 60947-1
 - IEC 60947-3
 - in the vicinity of the equipment (recommendation)
- Flame-resistant (cables and lines), in compliance with the following regulations
 - UL 2556 VW-1 (for USA, Canada)
 - IEC 60332-1-2 (outside of USA, Canada)



For details on the conditions at the installation site, see chapter 7. Technical data,  107.

3.3.2 General installation instructions









This section describes the installation of the P 700 IQ with various especially designed accessories. We assume that the operator uses these accessories. In this section, the individual scopes of delivery are not distinguished so the comprehensibility of the instructions is not affected.

Pay attention to the following points during installation:

- Installation in the open should be carried out while the weather is frost-free.
- Due to its weight, the analyzer always has to be carried by two people (housing door upward, both people grasp the housing at the upper C rail and at the housing bottom on the side of the door).
- The analyzer may only be fastened to a wall or fixture with the aid of the two rails (housing upright).



Main steps

Installation of the P 700 IQ includes the following main steps:

- 1 Installing the housing.
See section 3.3.3,  24.
- 2 Installing the FM filter membrane module and the M 1.5 attachment for filtration.
See section 3.3.4,  35.
- 3 Inserting the connections into the housing.
See section 3.3.5,  36.
- 4 Connecting the IQ SENSOR NET cable to the MIQ/WCA 232.
See section 3.3.6.1,  39.
- 5 Connecting the power line and heat tracing lines.
See section 3.3.6.2,  41.
- 6 Connecting the liquid containers.
See section 3.3.6.3,  43.

3.3.3 Installing the housing

The housing of the P 700 IQ can be installed in the following ways:

- On the SM stand mount. See section 3.3.3.1 Installation on the SM stand mount,  25.
- On a rail. See section 3.3.3.2 Installation on a rail,  30.

- On a wall. See section 3.3.3.3 Installation on a wall, 34.



In the housing there is a foam insert serving as a transport protection. Remove the foam insert once the installation of the housing has been completed.

3.3.3.1 Installation on the SM stand mount

Proceed as follows to install the housing on the stand mount:

Assembling the stand mount

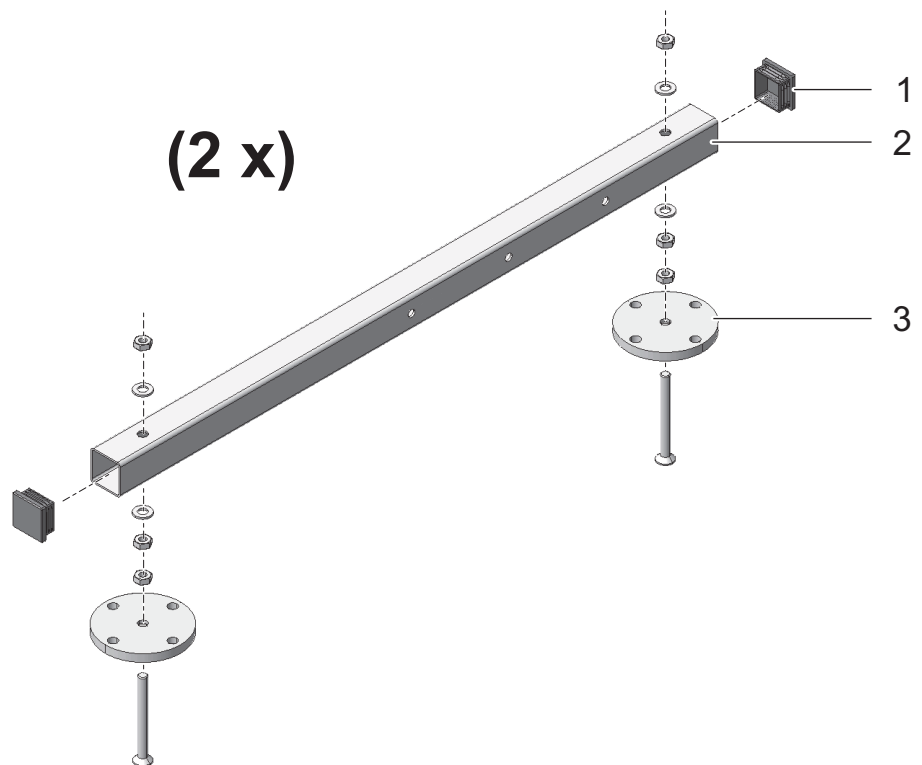

Fig. 3-1: Mounting the ground pipes

- 1 Press the plastic protective plugs (1) into both ends of the square ground pipes (2).
- 2 Mount the four height adjustable stand feet (3) on the square ground pipes (2) using the enclosed M10 hexagon countersunk head screws. Make sure to use the correct number of plain washers and nuts in the correct order according to Fig. 3-1, 25.

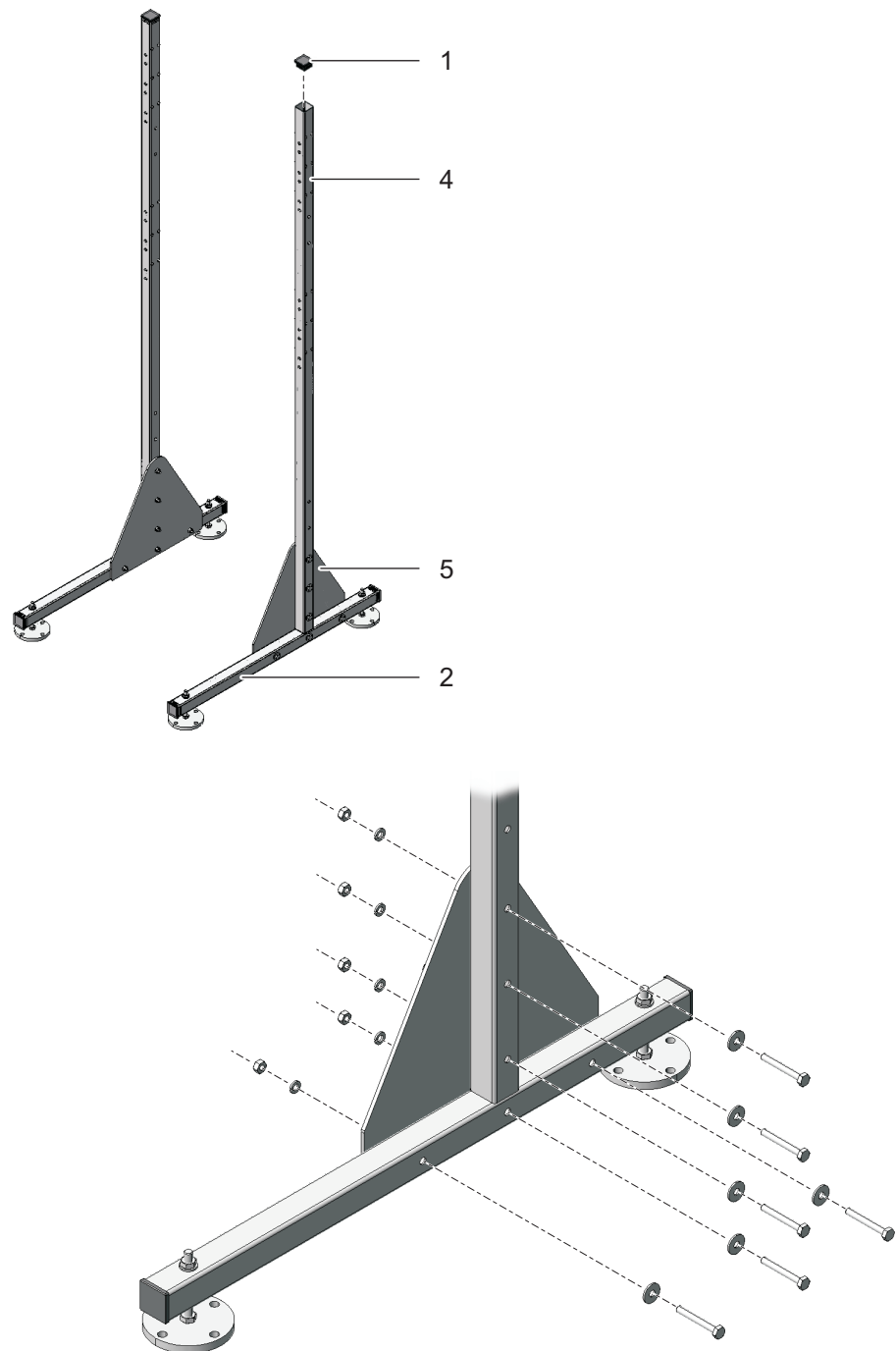

Fig. 3-2: Connecting the supporting pipes with the ground pipes

- 3** Press the plastic protective plugs (1) into the upper ends of both square supporting pipes (4).
- 4** Using the triangular stabilizing sheets (5), connect both square supporting pipes (4) with the preassembled ground pipes (2). For each side, use six hexagon head screws with large plain washers, spring washers and locknuts as shown in Fig. 3-2, 26. Make sure the two sides mirror each other after being mounted.

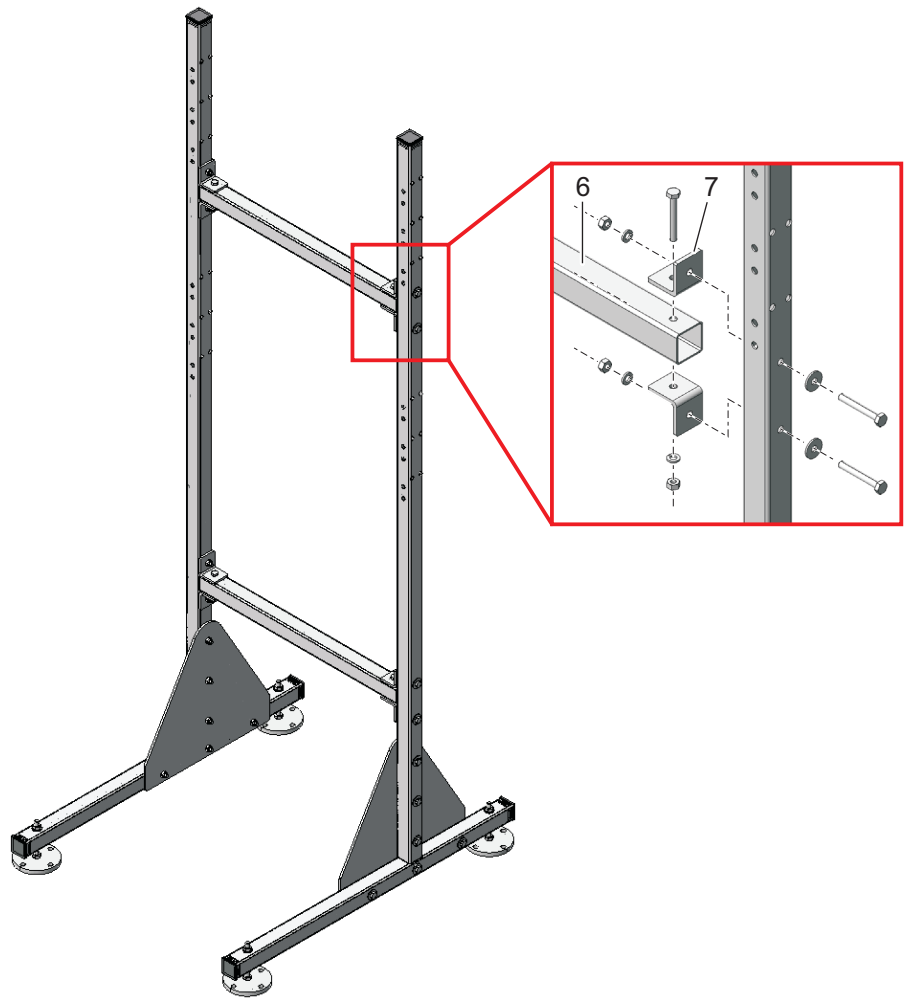

Fig. 3-3: Connecting the supporting pipes with the cross pipes

- 5 Connect both supporting pipes with each other using the two square cross pipes (6). For each joint, use two angle brackets (7), three hexagon head screws, two large plain washers, three spring washers and three locknuts.



Make sure that both triangular stabilizing sheets (5) are on the inside.

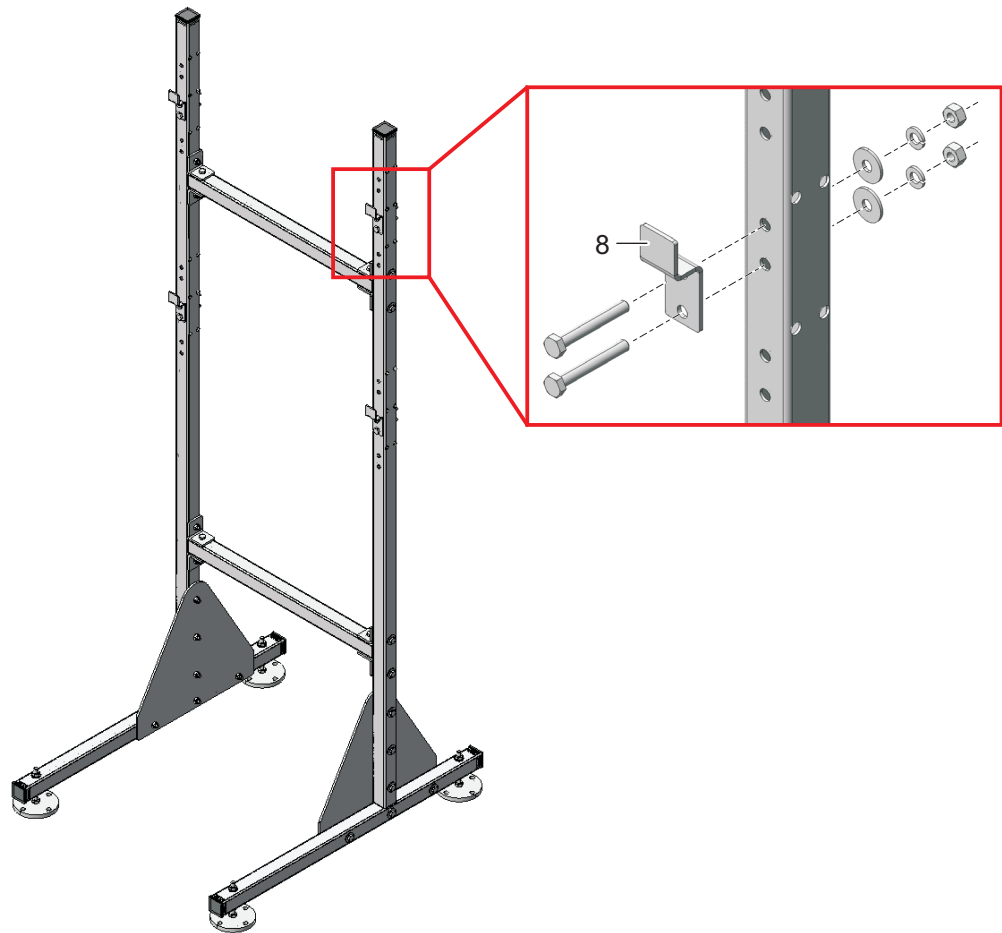

Fig. 3-4: Mounting the retaining hooks

- 6 Mount the four retaining hooks (8) on the supporting pipes. For each hook, use two hexagon head screws, large plain washers, spring washers and locknuts.



On each side there are three pairs of holes for the upper and lower retaining hooks. Thus the analyzer can be mounted optimally at working level. Use the same relative positions for each of the upper and lower hooks.

Positioning the stand mount

- 7 Position the stand mount at the intended operating location.
- 8 Adjust the four height adjustable stand feet so that the stand mount stands straight.



ATTENTION

Always screw the four stand feet to the ground. For installation at an open air test site, make sure that the installation will also withstand strong storms.

Mounting the housing

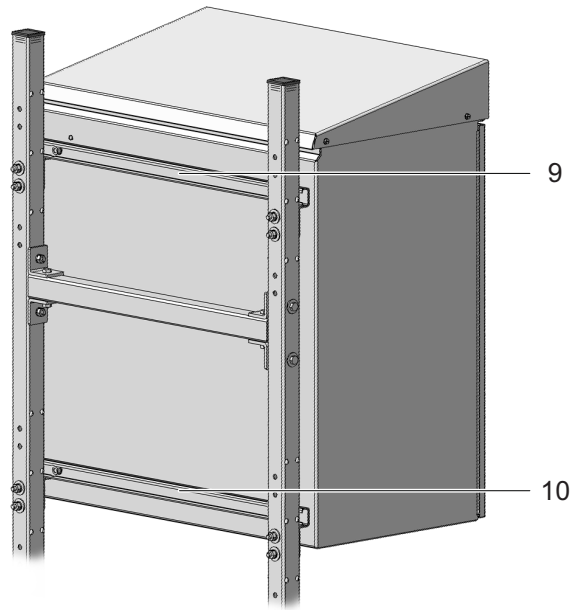

Fig. 3-5: Mounting the housing

- 9** Mount the housing by hooking the rails (9 and 10) fixed on its rear side into the retaining hooks of the stand mount.

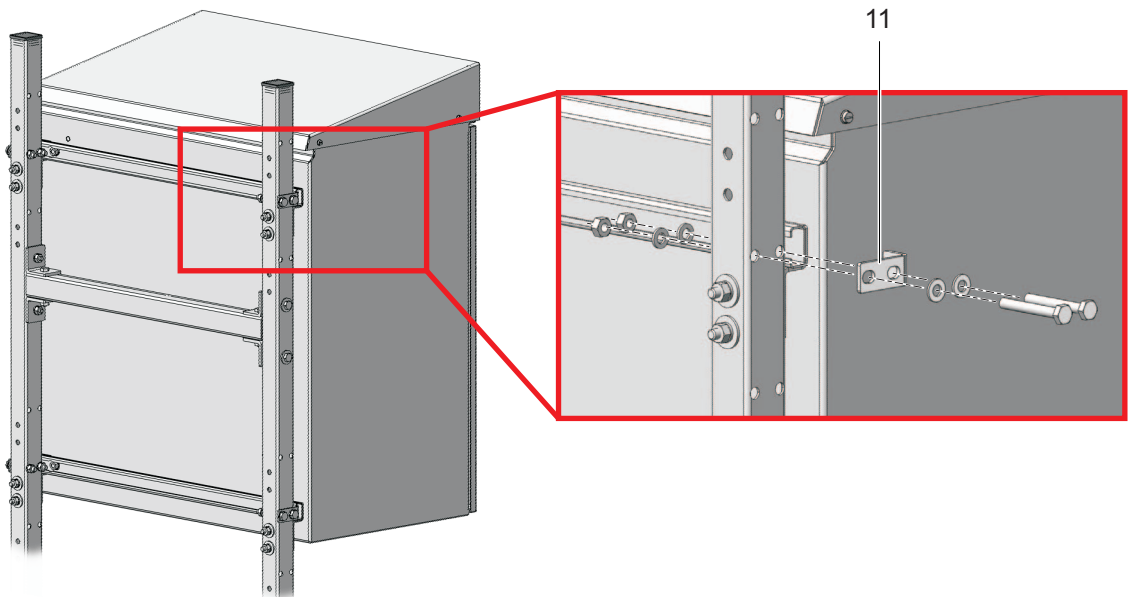



Fig. 3-6: Fixing the housing

- 10** Fix the housing on both sides with four brackets (11) so it cannot shift sideways. For each bracket, use two hexagon head screws, small plain washers, spring washers and locknuts.

3.3.3.2 Installation on a rail

For installation on a rail, the RM rail mount bracket is required.

	<h2 style="margin: 0;">ATTENTION</h2>
<p>Make sure that the rail is sufficiently stable. For installation at an open air test site, make sure that the installation will also withstand strong storms.</p>	

Assembling the bracket

Proceed as follows to install the housing on the rail:

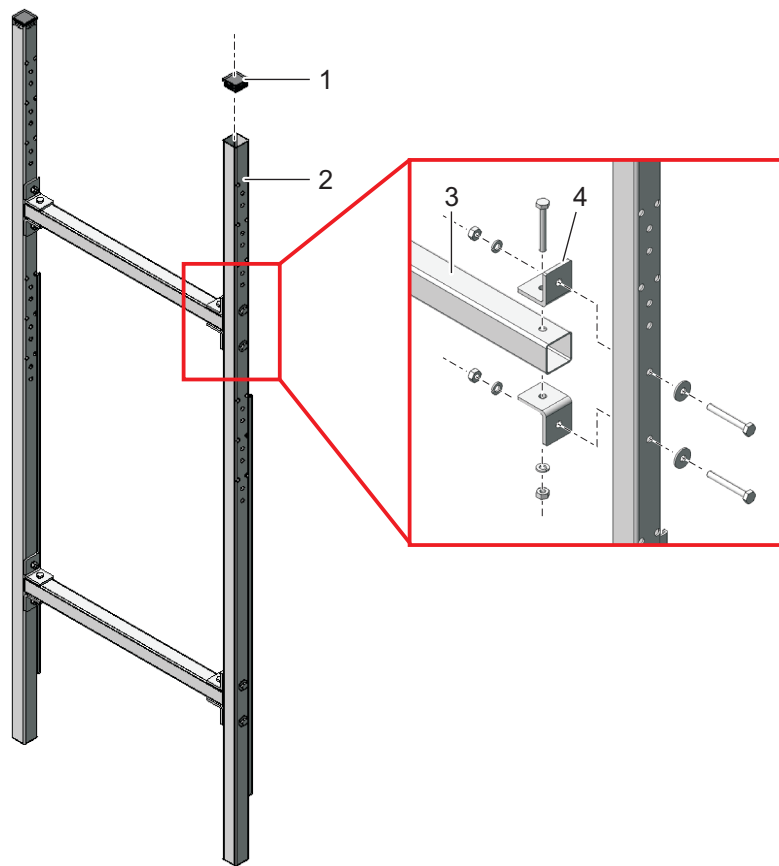

Fig. 3-7: Connecting the supporting pipes with the cross pipes

- 1 Press the plastic protective plugs (1) into the upper ends of both square supporting pipes (2).
- 2 Connect both supporting pipes with each other using the two square cross pipes (3). For each joint, use two angle brackets (4), three short hexagon head screws, two large plain washers, three spring washers and three locknuts as shown in Fig. 3-7, 30.

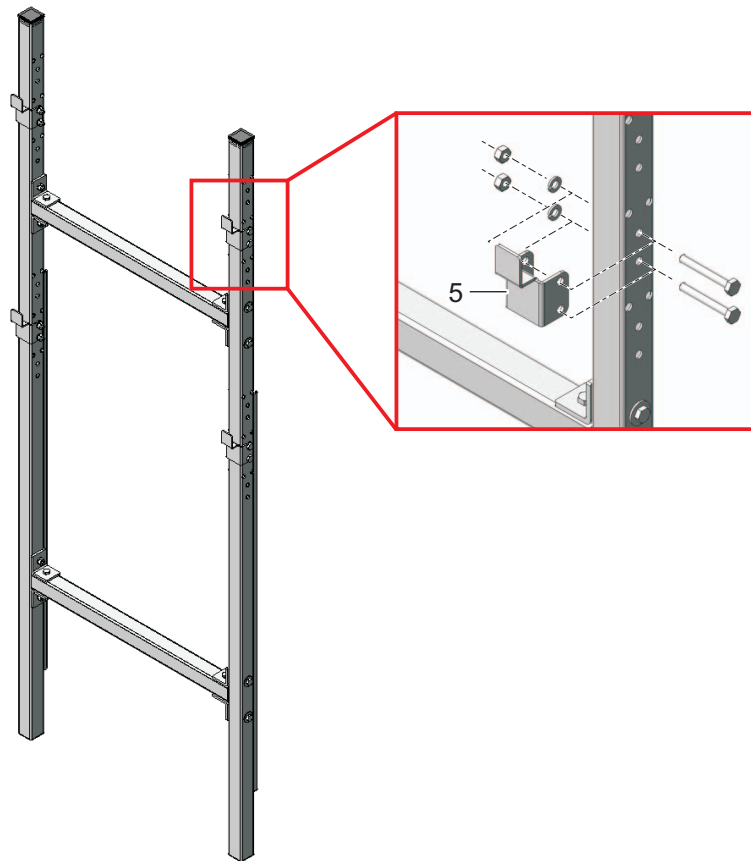

Fig. 3-8: Mounting the retaining hooks

- 3 Mount the four retaining hooks (5) on the supporting pipes. For each hook, use two short hexagon head screws, spring washers and locknuts.



There are three pairs of holes each for the upper and lower retaining hooks. Thus the analyzer can be mounted optimally at working level. Use the same relative positions for each of the upper and lower hooks.

Fixing the rail mount bracket

- Place the rail mount bracket in front of the rail in the required position.

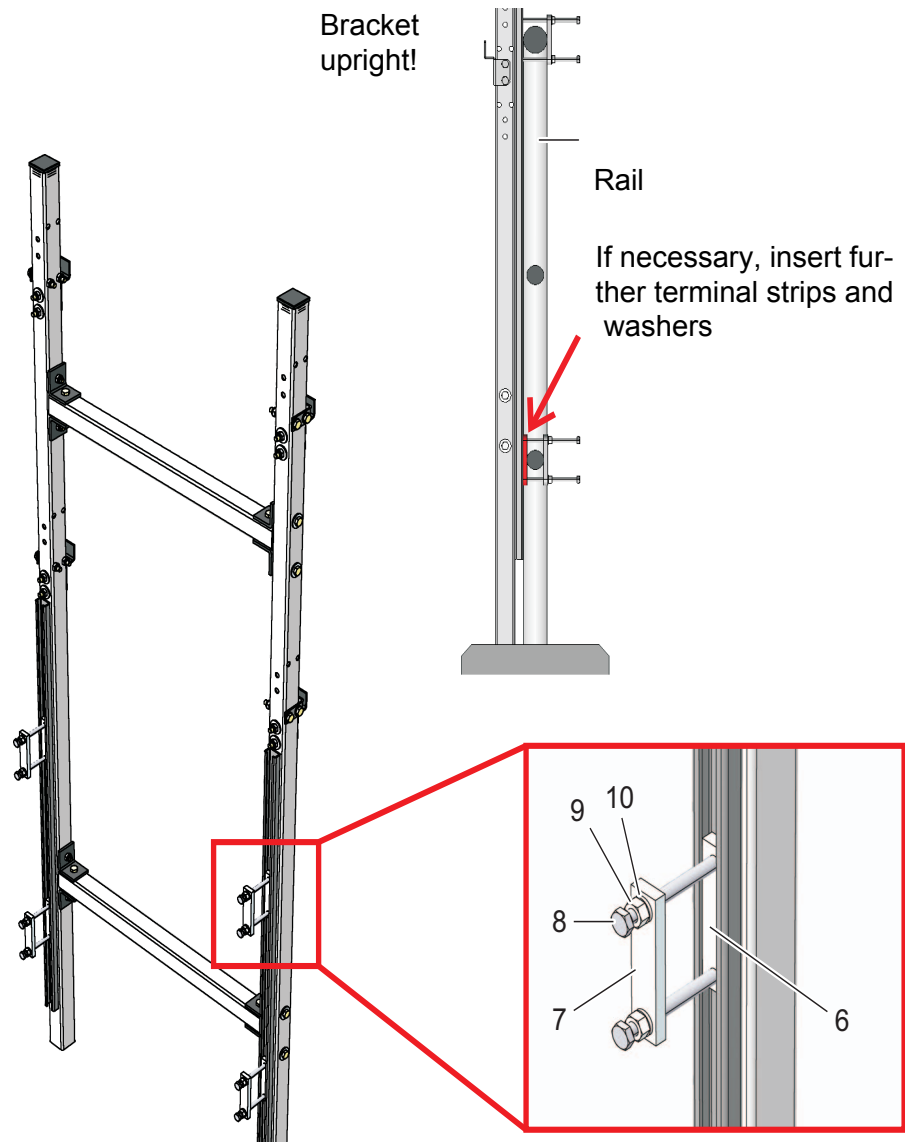

Fig. 3-9: Mounting the rail mount bracket on the rail

- Attach the rail mount bracket to two suitable horizontal rail pipes with the aid of the four clamping devices. Each clamping device consists of a groove bar (6), a terminal strip (7), two long hexagon head screws (8), two nuts (9) and two spring washers (10). Adjust the clamping devices to the rail pipes. To compensate for any possible differences of the upper and lower rail pipe diameters, 2 further terminal strips and 8 washers (thickness 2 mm) are provided with the construction set. If necessary, insert these items between the rail and supporting pipes as shown in Fig. 3-9, 32 so that the rail mount bracket is in a vertical position. Note that both supporting pipes must stand on the ground!



The weight of the analyzer is supported by the rail mount bracket standing on the ground. The rail prevents the analyzer from tilting over.

Mounting the housing

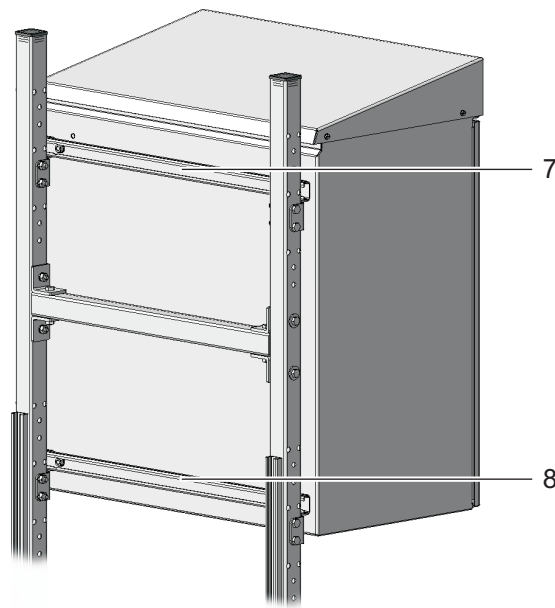

Fig. 3-10: Mounting the housing

- 6** Mount the housing by hooking the rails (7 and 8) fixed on its rear side into the retaining hooks of the rail mount bracket.

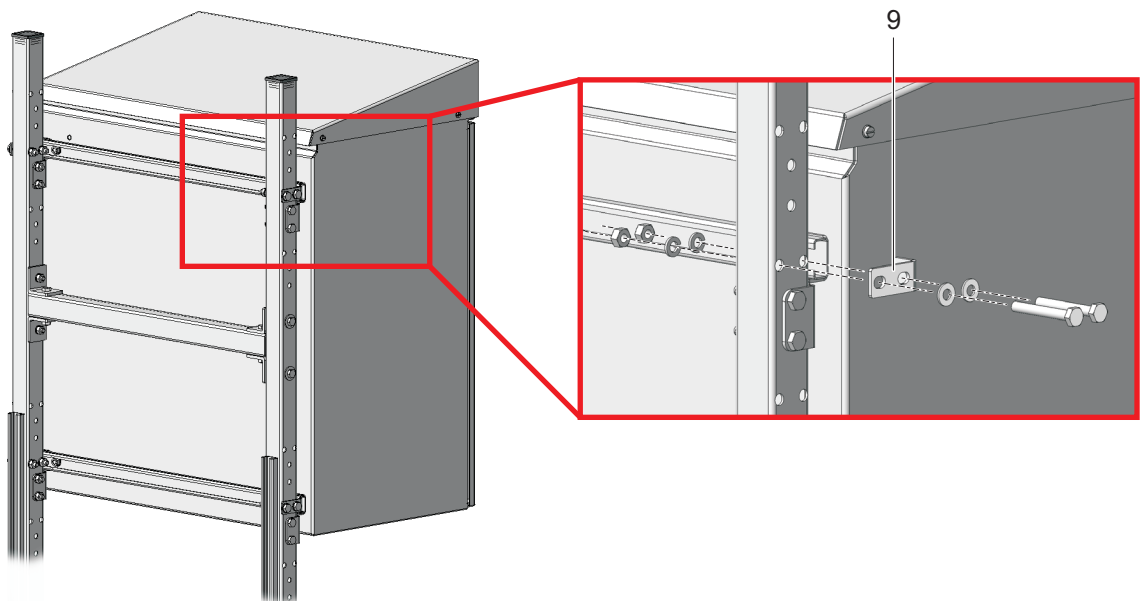



Fig. 3-11: Fixing the housing (on the right: Detailed view)

- 7** Fix the housing on both sides with four brackets (9) so it cannot shift sideways. For each bracket, use two short hexagon head screws, small plain washers, spring washers and locknuts.

3.3.3.3 Installation on a wall

With the rails on its rear side, the analyzer is hooked into the retaining hooks of the WM wall mounting set.

	ATTENTION
	<p>Make sure that the wall is strong enough for the weight of the analyzer and that the mounting material (screws, plugs, etc.) is suitable for the wall type. If necessary, use other screws and plugs than the ones provided.</p>

Proceed as follows to install the housing on a wall:

- 1 Drill eight holes as shown in the following figure:

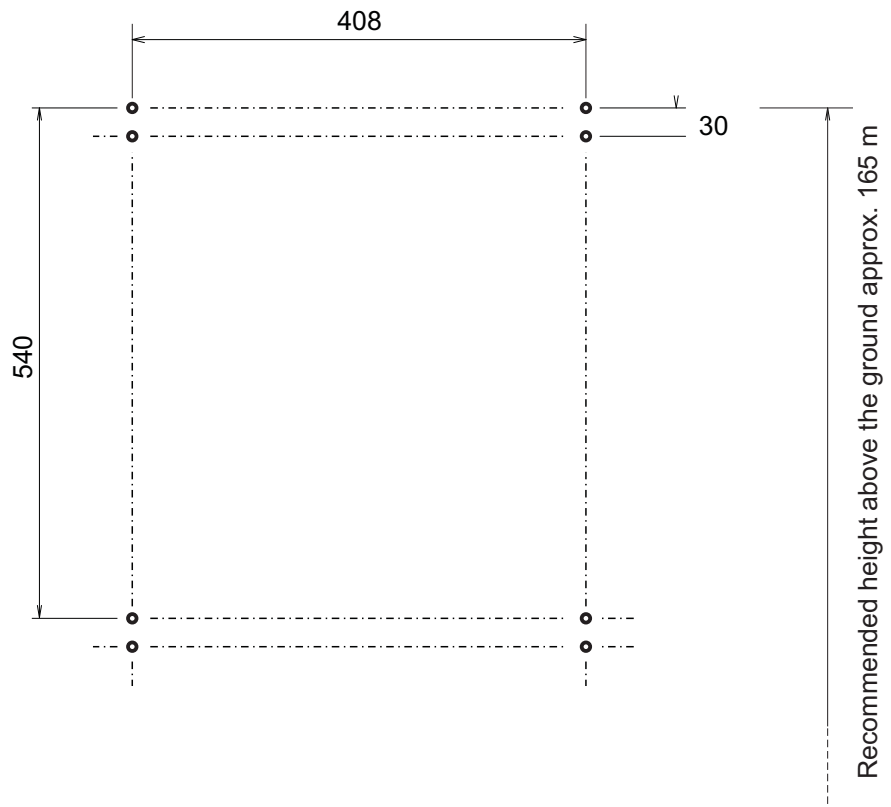

Fig. 3-12: Drilling dimensions for mounting the WM wall mounting assembly

- 2 Screw tight the four retaining hooks of the wall mounting set.
- 3 Mount the housing by hooking the rails fixed on its rear side into the retaining hooks. The fixing screws of the rail must be outside the retaining hooks on both sides as shown in the following figure:

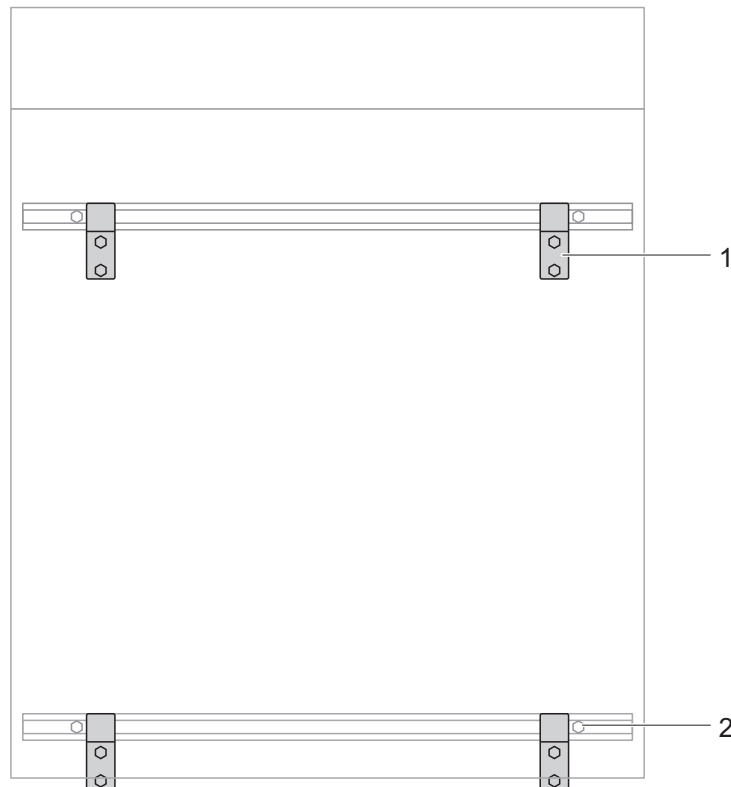

Fig. 3-13: Analyzer housing in the wall mounting assembly WM.

- 1 Retaining hook
- 2 Fixing screws of the rail

3.3.4 Installing the FM filter membrane module and the M 1.5 attachment for filtration

Installation instructions

Heed the following notes when installing the filter membrane module:

- Mount the filter membrane module so that the plate is in a position vertical to the flow direction.



In special cases (e.g. in a channel) it is better to mount the FM filter membrane module in a position horizontal to the flow direction.

An adapter for horizontal mounting is available as an accessory.

- The filter membrane module and the slide must be completely submersed (max. 40 cm).
Take changing water levels into account when mounting the filter membrane module.

- The lower edge of the filter membrane module must be mounted with least 10 cm distance to the bottom.

Installation

- 1 Mount the rail of the attachment for filtration in the basin. If necessary, extend the rail with the M-EXT 1.5 extension accessory.

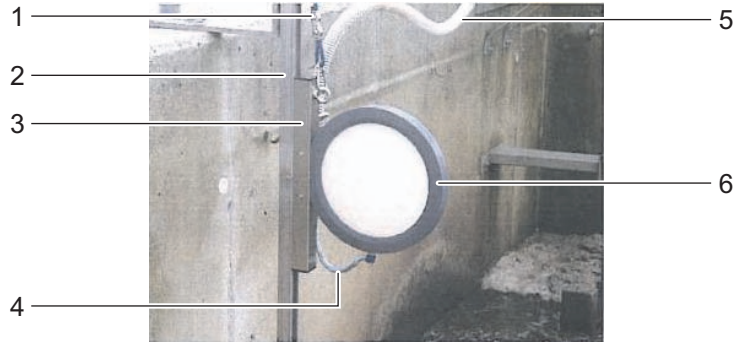

Fig. 3-14: Sample filtration device (installed)

- 1 Chain (scope of delivery: Attachment for filtration M 1.5)
- 2 Guide rail (scope of delivery: Attachment for filtration M 1.5)
- 3 Height adjustable slide (scope of delivery: Suction line)
- 4 Suction line (scope of delivery: Suction line)
- 5 Sleeve tube (scope of delivery: Suction line)
- 6 Filter membrane module FM with membrane insert

- 2 Mount the filter membrane module on the slide of the attachment for filtration.
- 3 Connect the suction line to the filter membrane module.
- 4 Insert the slide of the filter membrane module in the rail and lower it into the basin with the aid of the chain. Fix the end of the chain outside the basin.
- 5 Run the suction line to the analyzer. Fix the line with cable ties at some suitable places as necessary. How to connect the suction line to the P 700 IQ, see section 3.3.5, 36.

3.3.5 Inserting the connections into the housing

Connection plate

All connections are inserted into the housing through dust-proof lead-in ducts. The lead-in ducts are on a connection plate in the bottom of the housing. The connection plate can be removed for mounting the tubes.

- 1 Unscrew the connection plate from the bottom of the housing.
- 2 Run the power line through the small cable gland on the left. Fix the power line only slightly for the time being so that it can be readjusted later.

- 3 Run the IQ SENSOR NET cable through the small rear cable gland. Fix the IQ SENSOR NET cable only slightly for the time being so that it can be readjusted later.



If the IQ SENSOR NET should be further branched at the MIQ/WCA 232, insert the IQ SENSOR NET cable leading away through the small front cable gland.

Connecting the filter unit and return tube (accessories)

- 4 Run the suction line through the big cable gland on the left side of the connection plate.
 - The sleeve tube should stick out approx. 5 cm behind the connection plate.
 - Fix the sleeve tube with the cable gland.
- 5 Run the return tube through the big cable gland on the right side of the connection plate.
 - The sleeve tube should stick out approx. 5 cm behind the connection plate.
 - Fix the sleeve tube with the cable gland.



The liquid from the return tube must be able to drain off freely (downward incline). Do not immerse the end of the hose in water. The sample must be able to drain off freely.

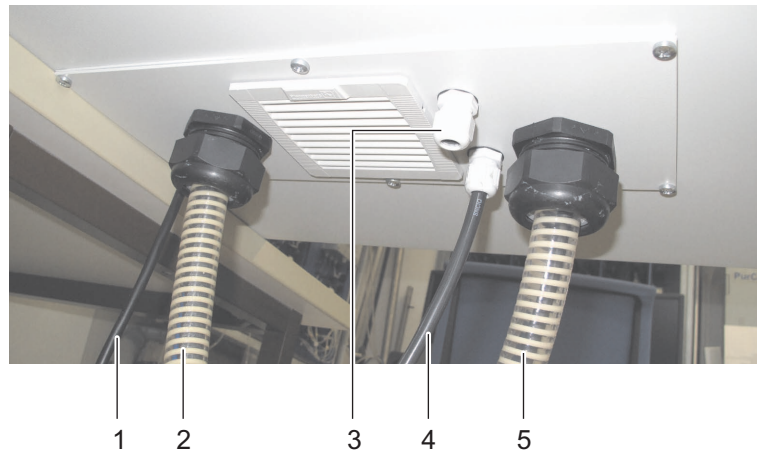

Fig. 3-15: Connection plate on the underside of the housing

- 1 Power line
- 2 Sleeve tube of the suction line
- 3 Lead-in duct for the IQ SENSOR NET branching (option)
- 4 IQ SENSOR NET cable
- 5 Sleeve tube of the return tube

- 6 Screw the connection plate with the preassembled tubes to the bottom of the housing again. See Fig. 3-15, 37.



All open cable glands must be closed with suitable plugs.

3.3.6 Connecting the lines

Fig. 3-16, 38 shows the housing with the completely connected lines including the accessories and all options:

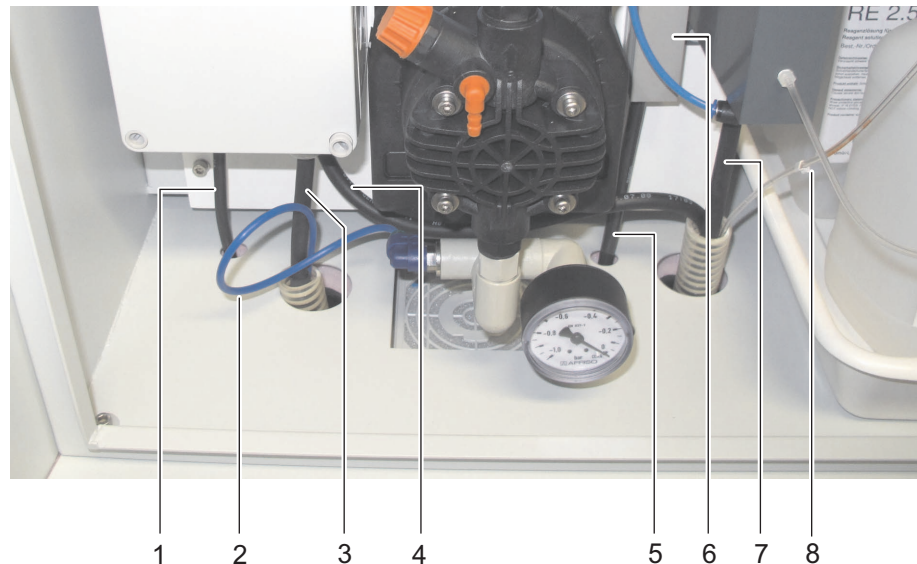

Fig. 3-16: Completely connected lines

- | | |
|---|---------------------------------|
| 1 Power line | 5 IQ SENSOR NET cable |
| 2 Suction tube | 6 Cable duct |
| 3 Heat tracing of the suction line (option) | (IQ SENSOR NET-cable) |
| 4 Heat tracing of the return tube (option) | 7 Outlet of the overflow vessel |
| | 8 Outlet of the photometer unit |

Proceed as follows to connect the individual lines:

- 1 Connect the intake tube (2) to the filtration pump.
- 2 Insert the outlet of the overflow vessel and the outlet of the photometer unit into the sleeve tube of the return tube.



The liquid from the return tube must be able to drain off freely (downward incline). Do not immerse the end of the hose in water. The sample must be able to drain off freely.

- 3 Connect the IQ SENSOR NET cable to the MIQ/WCA 232. See section 3.3.6.1 Connecting the IQ SENSOR NET cable to the MIQ/WCA 232, 39.
- 4 Connect the power line (1) and, if necessary, the heat tracing lines (3 and 4) to the power supply box. See section 3.3.6.2 Connecting the power line and heat tracing lines, 41.

	ATTENTION
	<p>No other consumers, with the exception of those described in this operating manual, must be connected to the mains box.</p> <p>Line branches in the supply lines are not permitted.</p>

- 5 Tighten all cable glands after the connections have been made.

3.3.6.1 Connecting the IQ SENSOR NET cable to the MIQ/WCA 232

To connect the MIQ/WCA 232 to the IQ SENSOR NET, use the outward right-hand connector of the terminal strip ("SENSORNET 1"). The connection left of this one can be used for branching ("SENSORNET 2").

Proceed as follows to connect the IQ SENSOR NET cable to the MIQ/WCA 232:

- 1 Guide the IQ SENSOR NET cable through the connection plate of the P 700 IQ (see chapter 3.3.5 Inserting the connections into the housing,  36).



For connecting the MIQ/WCA 232 to the IQ SENSOR NET, use only the IQ SENSOR NET cable designed for the IQ SENSOR NET (SNCIQ, SNCIQ/UG, SACIQ, see chapter 7.4 Electrical data,  112). Other cables are not permitted.

- 2 Connect the IQ SENSOR NET cable to the MIQ/WCA 232.

	ATTENTION
	<p>No other IQ module may be docked on the MIQ/WCA 232, except a terminal for maintenance work.</p>



Detailed information on the connection of the IQ SENSOR NET cable to the MIQ/WCA 232 and on branching is given in the respective IQ SENSOR NET system operating manual, topic, "distributed mounting".

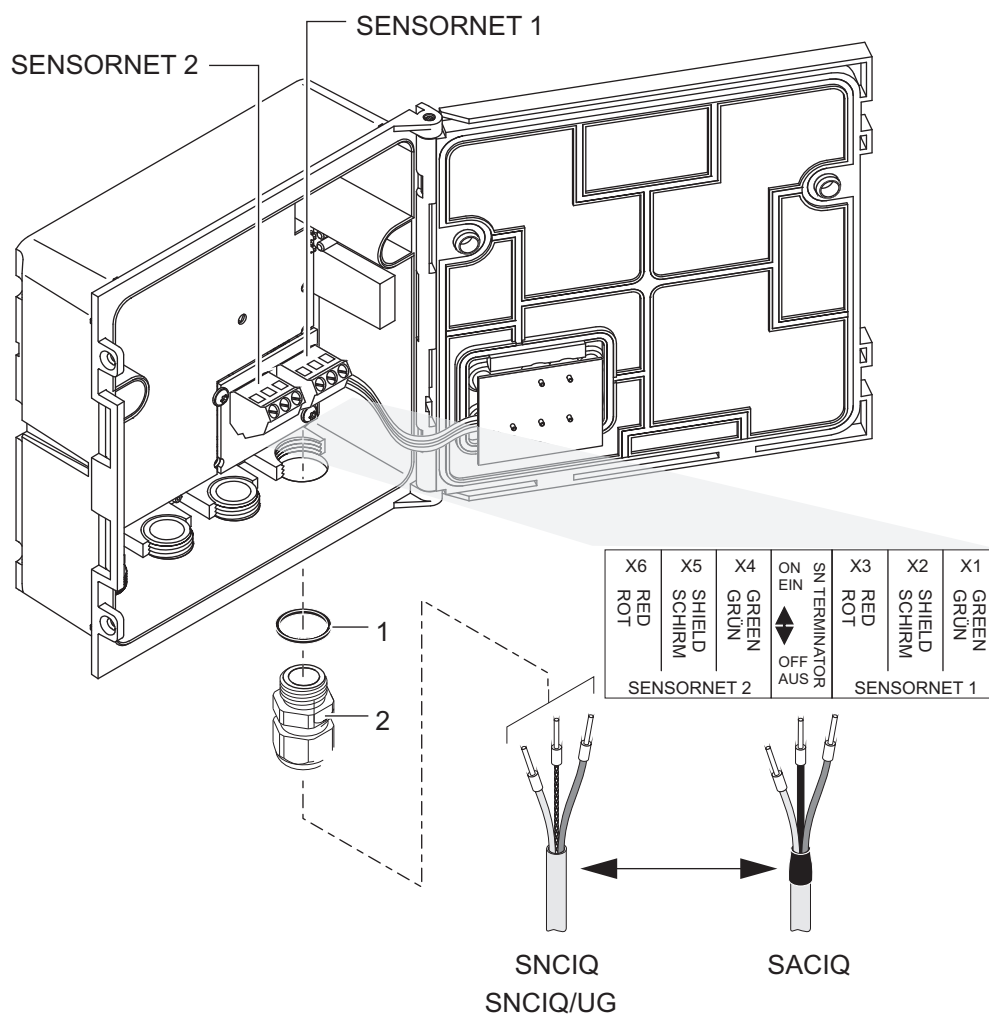





Fig. 3-17: Terminal strip of the MIQ/WCA 232

- 1 Seal
- 2 Cable gland

- 3 Guide the IQ SENSOR NET cable through the cable duct (see Fig. 3-16, 38).
- 4 Tighten the cable screw fittings on the MIQ/WCA 232 when all connections are made.

3.3.6.2 Connecting the power line and heat tracing lines

 WARNING	
	<p>If the power supply is connected incorrectly, there may be danger to life from electric shock.</p> <p>Pay attention to the following points during installation:</p> <ul style="list-style-type: none">• The power supply box may only be connected to the power supply by a qualified electrician.• The power supply box may only be connected to the power supply when it is not carrying any voltage.• The power supply must meet the specifications quoted on the name plate and in chapter 7. Technical data,  107.



We recommend installing an additional external power interrupter in order to switch the power supply box potential free from outside.

Proceed as follows to connect the power line and, if necessary, the heat tracing lines:

- 1 De-energise the power line.
- 2 Set the switch of the power supply box to OFF (0 pressed).
- 3 Remove the lid of the power supply box.

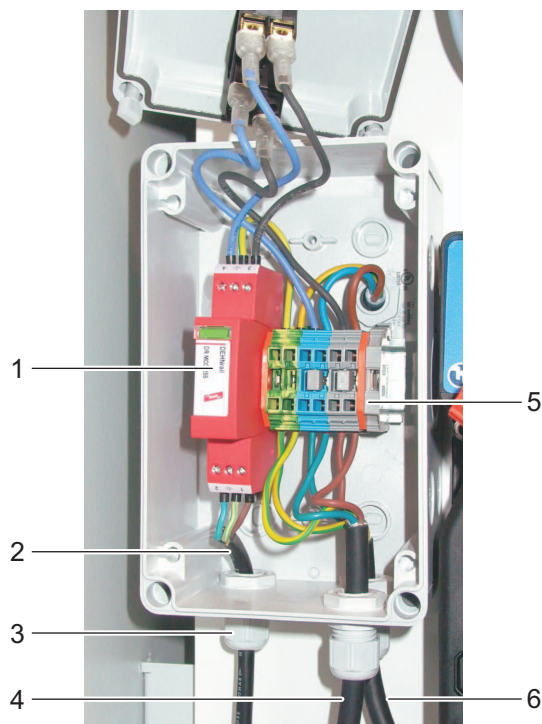

2		1	Eingang/ Input
N	PE	L	230 VAC / 16 A

PE	PE	N	N	L	L
Begleitheizung 230 VAC Heating Line 230 VAC					

2		1	Eingang/ Input
N	PE	L	115 VAC / 16 A

PE	PE	N	N	L	L
Begleitheizung 115 VAC Heating Line 115 VAC					

Fig. 3-18: Power supply box (lines installed)

- 1 Overcurrent protection
- 2 Power line
- 3 Cable gland
- 4 Heat tracing of the suction line (option)
- 5 Connecting terminals
- 6 Heat tracing of the return tube (option)

- 4 Insert the power line (2) through the cable gland (3).
- 5 Connect the power line to the overcurrent protection (1) as shown in Fig. 3-18, 42.
- 6 Insert the heat tracing lines for the return tube (6, rear) and for the suction line (4, front) through the cable glands on the right side.
- 7 Connect the heat tracing lines to the relevant terminals as shown in Fig. 3-18, 42.



The heating bands of the heat tracing lines must start within the P 700 IQ analyzer housing to keep the lines frost free. At the outlet of the return tube, the heat tracing must stick out 10 to 20 mm. If necessary, shift the heat tracing in the sleeve tube accordingly.

- 8 Tighten the cable glands on the power supply box.
- 9 Mount the lid of the power supply box.

3.3.6.3 Connecting the liquid containers



For installation in the open and ambient temperatures below 0 °C, make sure that the liquids do not freeze during the commissioning. If necessary, switch on the power supply box beforehand and let the housing warm up with the doors closed (see section 3.4 Initial commissioning,  45).



- 1 Place the chemicals tray on the bottom of the analyzer.
- 2 Mount the lids of the lid set on the luer connectors. The lids are color coded.
- 3 Put on your personal protective equipment (PPE) and chemical resistant gloves (see section 2.3 Personal protective equipment (PPE),  19).
- 4 Open the lid of the liquid container to be connected.
- 5 Place the liquid container in the chemicals tray and screw the relevant preassembled lid on the container. The lids with the color coded connectors are included in the scope of delivery. The color coding of the container must correspond to the color coding of the lid (see Fig. 3-19,  44)!



Fig. 3-19: Chemicals container (connected)

- 1 Color coding of the preassembled lid
- 2 Color coding of the container
- 3 Chemicals tray

- 6** Connect all liquid containers:
- Reagent (green)
 - Cleaning solution (blue)
 - Standard solution (orange)



Use the calibration standard solution suitable for your measuring range.

Keep the original lids of the containers. They can be screwed on again for disposal.

- 7** Connect the sample tube.
- 8** Mount the outlet tube into the return tube.
- 9** Check that all other connections are correctly connected (sample tube connected between the overflow vessel and photometer unit, outlet tube inserted in the return tube).



The P 700 IQ has an extra counter for each liquid container (see chapter 5.4.1 Changing the liquid containers, 77). When delivered, the counters are set to 100 %.

3.4 Initial commissioning

Steps for commissioning the analyzer

- 1 Make sure that all liquid containers are correctly connected, and all lines and tubes are correctly installed.
- 2 Set the switch of the power supply box to ON (I pressed).



Important for operation (especially in the open): If the temperature inside the housing is outside the range +15 ... +40 °C, close both housing doors and allow the instrument to get warm for a sufficiently long period of time (provided that there is a climate kit). Only then proceed with the further steps. Do not leave the doors open unnecessarily.

- 3 Use the arrow keys to set the pump capacity to 80 ... 100 %.

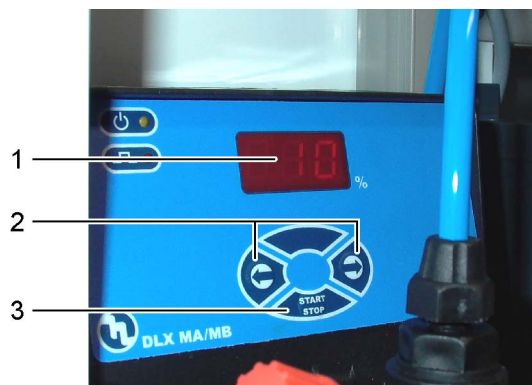

Fig. 3-20: Filtration pump

- 1 Pump capacity in %
- 2 Arrow keys
- 3 Start/Stop key

- 4 Switch on the filtration pump with the Start/Stop key.
- 5 Wait until sample liquid runs from the overflow vessel into the return tube. Depending on the length of the intake tube, this may take some minutes.



If no sample runs into the overflow vessel, proceed in one of the following ways:

- Fill the suction line with water manually:
 - Switch off the filtration pump.
 - Pull the intake tube off the filtration pump.
 - Fill the intake tube with water (e.g. using a wash bottle).
 - Connect the intake tube to the pump again and secure it.
 - Switch on the filtration pump.

- Increase the suction power manually:
 - At the vent connection (2), connect a syringe with a tube:
 - Open the vent valve (1).
 - Create an additional negative pressure with the syringe.
 - Close the vent valve (1).
 - Repeat the procedure until sample runs into the overflow vessel.
 - Remove the tube and syringe from the vent connection (2).

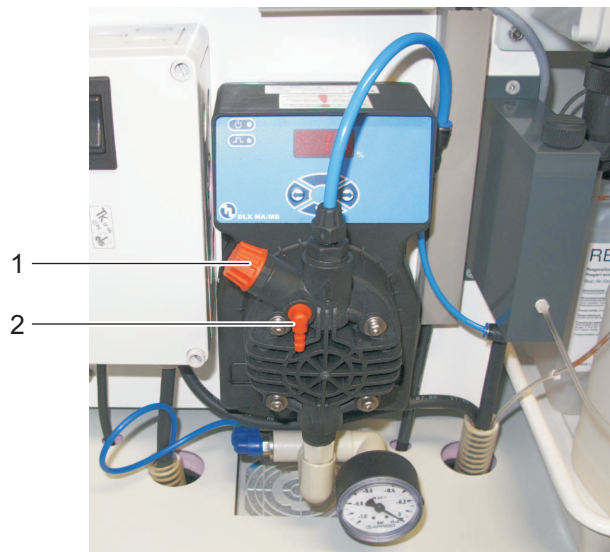



Fig. 3-21: Filtration pump

- 1 Vent valve
- 2 Vent connection

- 6 As soon as enough sample is running, reduce the pump power to 5 - 10 % with the aid of the arrow keys.
- 7 Close the doors of the housing.
- 8 If necessary, commission the IQ SENSOR NET system (see the relevant IQ SENSOR NET system operating manual).

Commissioning steps on the IQ SENSOR NET terminal

The following steps are carried out on a terminal in the IQ SENSOR NET system. Instructions for operation are given in the respective IQ SENSOR NET system operating manual.

- 9 Use <▲▼> to select the P 700 IQ in the measured value display.
- 10 Use <C> to switch to the calibration and service menu. The maintenance condition is activated.
- 11 Confirm the maintenance condition with <OK>. The calibration and service menu is displayed. See Fig. 3-22,  47.

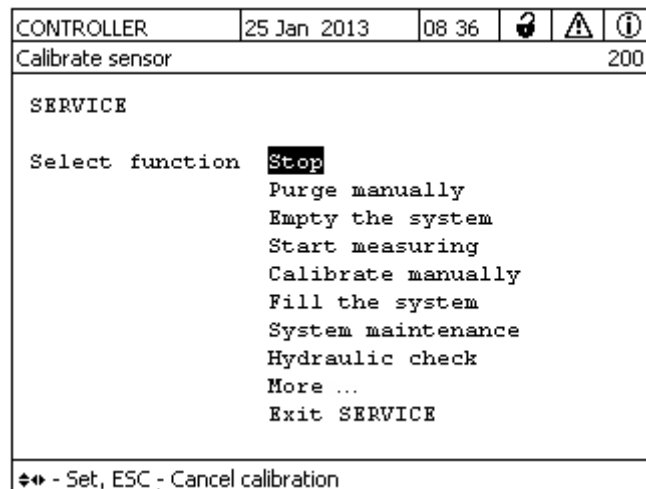

Fig. 3-22: Calibration and service menu

- 12 Carry out the *Fill the system* function. All tubes of the P700IQ-PO4 are automatically filled with the connected solutions and sample liquid.
- 13 Follow the instructions on the display.
- 14 Carry out the *Start measuring* function. The measured value determination takes approx. 5...7 minutes. A note is displayed.



If the measurement is delayed because a function with higher priority (e.g. automatic cleaning or calibration) is carried out beforehand, this is indicated by a message such as WAIT CLEAN.

Starting the measurement

- 15 Confirm the start of the measurement with <OK>.
- 16 Carry out the *Exit SERVICE* function.
or
Exit the calibration and service menu with <ESC>. A note to end the maintenance condition is displayed.

- 17 Confirm the note with **<OK>**.
The measured value display appears. Until a valid measured value is available, the display shows bars «- - -».
- 18 Wait until a measured value is shown on the measured value display (approx. 5...7 minutes).

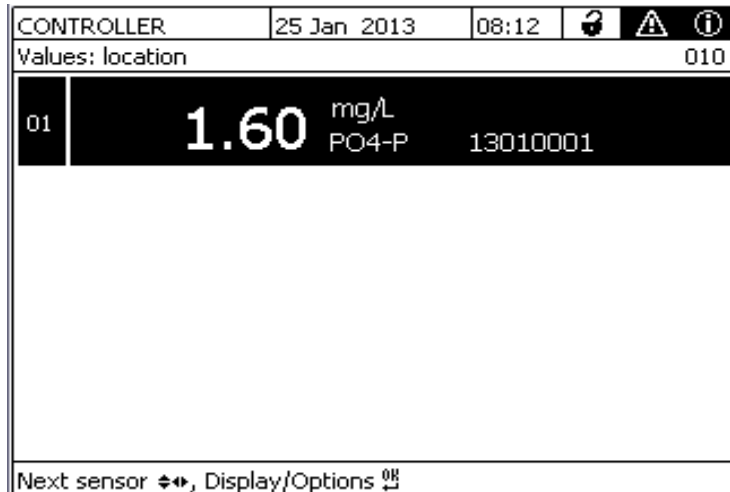

Fig. 3-23: Measured value display

- 19 Switch off the maintenance condition. See the IQ SENSOR NET system operating manual.



After the initial commissioning, the P 700 IQ works with the factory calibration. If the measured values are not as expected, further actions and correction settings are available:

- Cleaning (in the calibration and service menu)
- Calibration, see section 4.2 Calibration, 54
- Offset correction

4. Measuring / Operation

4.1 Measuring operation

4.1.1 Determination of measured values

The P 700 IQ determines the measured values with a chemical analyzing procedure. Each measurement takes place in several steps.

- 1 Draw some sample and rinse the measuring circle with sample
- 2 Measure the absorbance of the sample without reagent (blank value)
- 3 Add the reagent
- 4 Leave to react for the reaction time
- 5 Measure the absorbance of the sample with reagent

The measured values are determined at intervals specified in the settings (see section 4.1.4,  51).

If the intervals overlap with the specified start times and intervals of other functions (*Autom.cleaning* or *Autom.calibration*), the functions are carried out according to their priority (see section 4.1.4,  51).

4.1.2 Starting the measuring operation

Prior to starting the measuring operation, you always have to check the readiness for operation of the individual components of the P 700 IQ.

The analyzer does not automatically start measuring when connected to the IQ SENSOR NET.

Start the measuring operation manually in the calibration and service menu.

- 1 Use <▲▼> to select the P 700 IQ on the measured value display.
- 2 Use <C> to switch to the calibration and service menu. The maintenance condition is activated.
- 3 Confirm the maintenance condition with <OK>. The calibration and service menu is displayed.

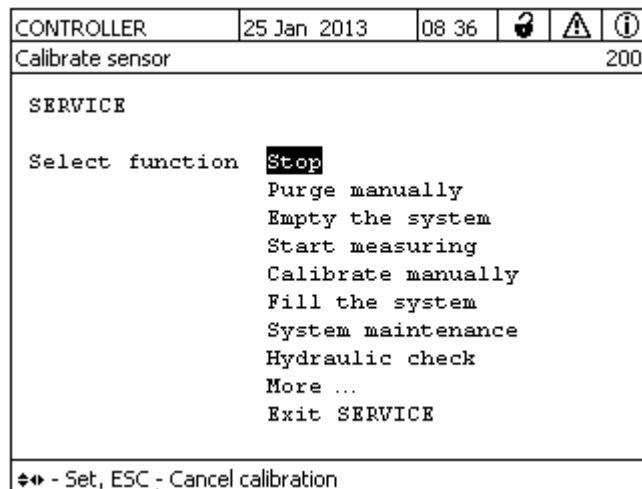

Fig. 4-1: Calibration and service menu

- 4 If the system is not yet filled:
Carry out the *Fill the system* function.
All tubes of the P700IQ-PO4 are automatically filled with the connected solutions and sample liquid.
- 5 Carry out the *Start measuring* function.
The measured value determination takes approx. 5...7 minutes.



If the measurement is delayed because a planned cleaning or calibration procedure is carried out beforehand, an info message is displayed.

- 6 Follow the instructions on the display.
- 7 Carry out the *Exit SERVICE* function.
or
Exit the calibration and service menu with **<ESC>**.
A note to end the maintenance condition is displayed.
- 8 Confirm the note with **<OK>**.
The measured value display appears. Until a valid measured value is available, the display shows bars «- - -».
- 9 Wait until a measured value is shown on the measured value display (approx. 5...7 minutes).
- 10 Switch off the maintenance condition.
See the IQ SENSOR NET system operating manual.

During measuring operation, the measurements take place at the specified intervals.

4.1.3 Measuring

The measured values are displayed on the measured value display on the terminal.

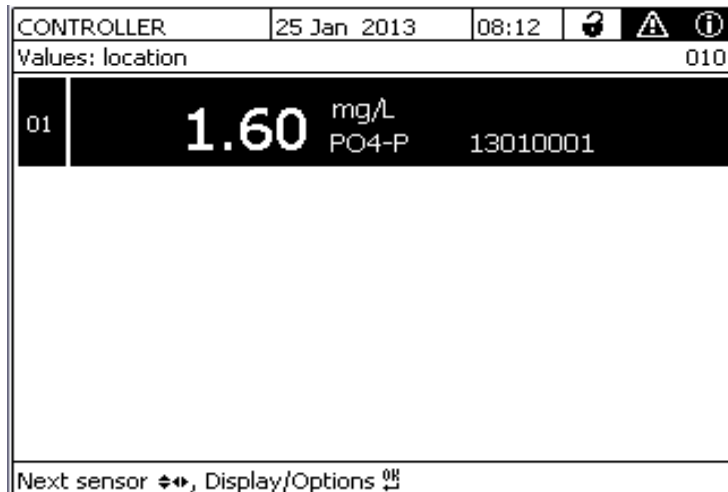

Fig. 4-2: Measured value display



During an automatic cleaning or calibrating procedure, the display shows CLEAN or CAL instead of a measured value. Linked outputs are frozen.

Measured value display	Function
CLEAN	<i>Autom. cleaning</i> is being carried out.
CAL	<i>Autom. calibration</i> is being carried out.

Tab. 4-1: Measured value display during a cleaning or calibrating procedure

4.1.4 Settings for the P 700 IQ

Start the measuring operation so the measured values of the P 700 IQ can be displayed (see section 4.1.2 Starting the measuring operation, 49). The P 700 IQ starts the first measurement immediately.

Selecting P 700 IQ

- 1 Use the <M> key to switch to the measured value display as necessary.
- 2 Use <▲▼> to select the P 700 IQ on the measured value display as necessary.
- 3 Use <S> to switch from the measured value display to the main menu of the sensor settings.

- 4 Then navigate to the setting menu of the P 700 IQ. The exact procedure is given in the relevant IQ SENSOR NET system operating manual.
- 5 Adjust the setting values as necessary.

Setting table

Tab. 4-2, 54 shows the setting menus with the possible values to be set. Default values are marked in bold.

Setting menu	Possible values	Description
Measuring mode	PO4-P PO4	The measured parameter is displayed in the selected citation form.
Measuring range		Display of measured values
<ul style="list-style-type: none"> • Measuring mode PO4-P 	A: 0.05 .. 15.00 mg/L B: 1 ... 50 mg/L A: 0.05 ... 15.00 ppm B: 1 ... 50 ppm	For each measuring mode (PO4 / PO4-P) and each displayed unit (mg/L, ppm), a small measuring range (A) and a large measuring range (B) can be selected.
<ul style="list-style-type: none"> • Measuring mode PO4 	A: 0,15 .. 46,00 mg/L B: 3 ... 153 mg/L A: 0.15 ... 46.00 ppm B: 3 ... 153 ppm	The measuring range can only be selected when the P 700 IQ is stopped (calibration and service menu).
Offset correction	A: - 0.50 ... 0.00 ... + 0.50 mg/L B: - 5 ... 0 ... + 5 mg/L	A: Setting range for: <ul style="list-style-type: none"> • Measuring mode PO4-P and • Measuring range 0.05 .. 15.00 mg/L B: Setting range for: <ul style="list-style-type: none"> • Measuring mode PO4-P and • Measuring range 1 ... 50 mg/L For other measuring modes and measuring ranges, the value ranges are adjusted.
Meas. interval	5, 10 , 15, 20, 30, 45, 60 min 2, 4, 6, 8 , 12 h	Measuring interval (smallest measuring interval for measuring range B: 10 min.)
Damping	Off Signal smoothing median filter	Methods for filtering the signals A signal filter in the sensor reduces the limits of variation of the measured value.
<ul style="list-style-type: none"> • Signal smoothing <ul style="list-style-type: none"> • Response time t90 	100 , 200, 300, 400 s	The signal filter is essentially characterized by the response time t90. Response time of the signal filter (in seconds). This is the time after which 90 % of a signal change is displayed.

Setting menu	Possible values	Description
<ul style="list-style-type: none"> <i>median filter</i> 		The equipment displays the average value of the last measured value.
<i>Autom.cleaning</i>	<i>On</i> <i>Off</i>	Switches the automatic cleaning function on or off
<ul style="list-style-type: none"> <i>Interval</i> 	6, 12, 24 , 48, 96	Interval in h
<ul style="list-style-type: none"> <i>Ref.time hours</i> <i>Ref.time minutes</i> 	0... 7 ...23	Defines the start time from which the automatic cleaning procedures will take place at the set interval (default setting: 7:00 o'clock)
	0 ...59	
<ul style="list-style-type: none"> <i>Conditioning count of steps</i> 	<i>On</i> 1...5	Adjustable number of rinses subsequent to cleaning.
	<i>Off</i>	
<i>Autom.calibration</i>	<i>On</i> <i>Off</i>	Switches the automatic calibration function on or off
<ul style="list-style-type: none"> <i>Interval</i> 	6, 12, 24 , 48, 96	Interval in h
<ul style="list-style-type: none"> <i>Ref.time hours</i> <i>Ref.time minutes</i> 	0... 8 ...23	Defines the start time from which the automatic calibration procedures will take place at the set interval (default setting: 8:00 o'clock).
	0 ...59	
<i>Status (P700IQ-PO4)</i>		<p>A log book message with the current status is output.</p> <p>The status indicates the current situation of the P700IQ-PO4, e.g.</p> <ul style="list-style-type: none"> • Cleaning (ON/OFF) • Calibrating (ON/OFF/WAIT CLEAN) • Measuring (ON/OFF/WAIT CLEAN/WAIT CAL) • Filling levels of the liquid containers in % <p>Meaning</p> <ul style="list-style-type: none"> • ON: Function active • WAIT: Waiting for a cleaning cycle (WAIT CLEAN) or calibration cycle (WAIT CAL) to be performed at a specified point of time.
<i>Autostart</i>	<i>On</i> <i>Off</i>	Activate or switch off the automatic start of the P 700 IQ after a power failure
<i>Save and quit</i>		The P 700 IQ stores all changed settings and the display switches to the next higher level

Setting menu	Possible values	Description
<i>Quit</i>		The display switches to the next higher level without storing the new settings

Tab. 4-2: Setting menu



The *Autom.cleaning*, *Autom.calibration* and *Meas. interval* settings may result in the overlapping of the carrying out of different functions.

In this case, the functions are carried out according to priority.

Priority

Function	Priority	Duration (min)	Measuring range
<i>Autom.cleaning</i>	1	5	A, B
<i>Autom.calibration</i>	2	6 9	A B
Measurement	3	5 7	A B

Tab. 4-3: Priorities

4.2 Calibration

4.2.1 Overview

Why calibrate?



During operation, components of the P 700 IQ can age or become dirty and thus change their characteristics, e.g.:

- Flow-through cell
- LED
- Photo diodes
- Color reagent

Regular automatic or manual calibration procedures help you to recognize any changes to the measuring characteristics of the P 700 IQ.

When to calibrate?

Calibrate at regular intervals.

1-point calibration	<p>The offset of the characteristic curve can be adjusted with a regular 1-point calibration.</p> <p>The 1-point calibration can be carried out automatically at regular intervals. An additional 1-point calibration procedure can be started in the calibration and service menu at any time. See section 4.2.2,  55.</p>
2-point calibration	<p>The current slope and the offset of the characteristic curve are adjusted with a 2-point calibration.</p> <p>2-point calibration with two different standards can only be started manually from the calibration and service menu. See section 4.2.3,  58.</p>
Calibration record / Calibration history	<p>The result of a calibration procedure is stored in the calibration record and calibration history and can be viewed afterwards (see the relevant IQ SENSOR NET system operating manual).</p>
Maintenance condition	<p>During the calibration procedure, the P 700 IQ is in the so-called maintenance condition. All linked outputs remain at their current status. After a manual calibration has been finished, the maintenance condition has to be switched off manually. More detailed information on the maintenance condition is given in the respective IQ SENSOR NET system operating manual.</p>
Calibration steps	<p>Each calibration procedure takes place in several steps:</p> <ol style="list-style-type: none"> 1 Draw some calibration standard and rinse the measuring circle with calibration standard 2 Measure the absorbance of the calibration standard without reagent (blank value) 3 Add the reagent 4 Leave to react for the reaction time 5 Measure the absorbance of the calibration standard with reagent

4.2.2 1-point calibration

Automatic 1-point calibration

1-point calibration is carried out automatically at regular intervals during the measuring operation. The settings for the calibration interval and calibration time are carried out in the menu of the sensor settings. The standard used for automatic 1-point calibration is identified automatically. The following standards can be used for automatic 1-point calibration: ST 1.6, ST 8.0, ST 20.0.

Setting the calibration time and calibration interval (see chapter 4.1.4 Settings for the P 700 IQ, 51).

Manual 1-point calibration

1-point calibration can be started at any time as a manual calibration procedure whenever necessary. The calibration procedure is started and the standard to be used is set in the calibration and service menu. The following standards can be used for manual 1-point calibration: ST 0.0, ST 1.6, ST 8.0, ST 20.0.

Proceed as follows to carry out a 1-point calibration procedure manually:



A manual 1-point calibration with the same calibration standard used for automatic calibration can be carried out without opening the housing.

- 1 For conveniently working on site:
Dock an IQ SENSOR NET terminal onto an MIQ module in the vicinity of the analyzer, or onto the MIQ/WCA 232 module in the analyzer.



Fig. 4-3: IQ SENSOR NET terminal

Stopping the running operation

- 2 Use <▲▼> to select the P 700 IQ on the measured value display.

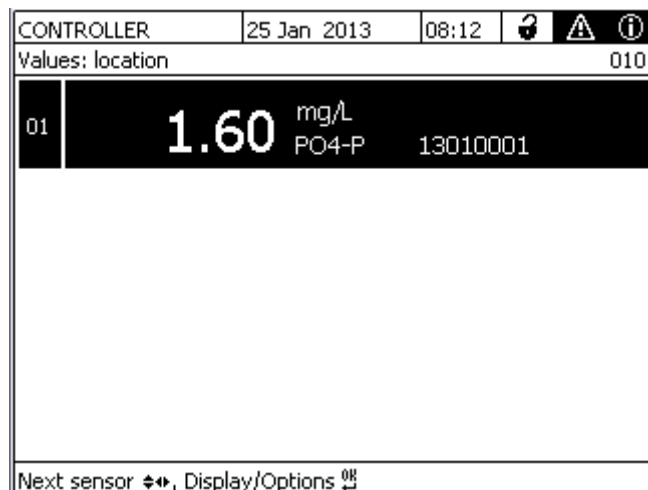

Fig. 4-4: Measured value display

- 3 Open the calibration and service menu with **<C>**.
The maintenance condition is activated.
- 4 Confirm the maintenance condition with **<OK>**.
The calibration and service menu is displayed.

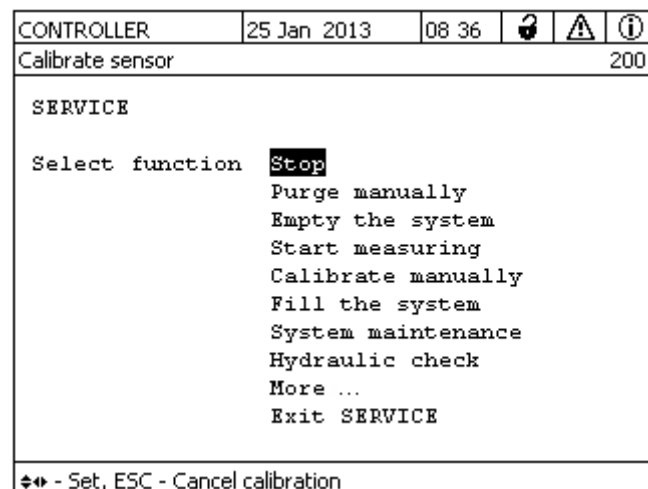

Fig. 4-5: Calibration and service menu



- 5 Carry out the *Stop* function to stop the running operation.
- 6 Option:
Carry out the *Purge manually* function to rinse the measuring cycle with cleaning solution.

Carrying out calibration

- 7 If necessary, connect the calibration standard which is to be used to carry out the manual calibration procedure.
- 8 Carry out the *Calibrate manually / 1-point-cal.* function.



You have the following possibilities if the calibration failed:

- Repeat the calibration procedure (make sure that the correct calibration standard is connected and selected for calibration).
- Use the last valid calibration (see section 4.2.5 Reactivating the last valid calibration,  62)
- Use the factory calibration (see section 4.2.5 Reactivating the last valid calibration,  62)

After the calibration standard has been measured, the calibration result is displayed (absorbance of the standard and t (offset)).

Restarting the measuring operation

- 9 If necessary, reconnect the calibration standard for automatic calibration.
- 10 Carry out the *Start measuring* function. Measurement is started and the measured value is displayed on the measured value display after approx. 5...7 minutes.
- 11 Carry out the *Exit SERVICE* function.
or
Exit the calibration and service menu with **<ESC>**.
- 12 Confirm the note with **<OK>**. The measured value display appears. The measured value flashes.
- 13 If necessary, disconnect the terminal from the MIQ/WCA 232.
- 14 Close the housing of the P 700 IQ.
- 15 Confirm the note with **<OK>**.
The measured value display appears. Until a valid measured value is available, the display shows bars «- - -».
- 16 Wait until a measured value is shown on the measured value display (approx. 5...7 minutes).
- 17 Switch off the maintenance condition.
See the IQ SENSOR NET system operating manual.

4.2.3 2-point calibration

2-point calibration is not carried out automatically.

A 2-point calibration procedure can be started manually at any time if necessary. For manual 2-point calibration, the housing has to be opened to connect a second calibration standard.

Proceed as follows to carry out a 2-point calibration procedure:

Opening the housing

- 1 Open the housing of the P 700 IQ.
- 2 If the ambient temperatures are under 0 °C, make sure that the liquids do not freeze during the calibration procedure.
 - Leave the housing of the P 700 IQ open for as short a time as possible
 - Only carry out a manual calibration if the interior of the P 700 IQ is at the right temperature ($+15\text{ °C} \leq T_{\text{Inner}} \leq +40\text{ °C}$).
- 3 For conveniently working on site:
Dock an IQ SENSOR NET terminal onto an MIQ module in the vicinity of the analyzer, or onto the MIQ/WCA 232 module in the analyzer.



Fig. 4-6: IQ SENSOR NET terminal

Stopping running operation

- 4 Use **<▲▼>** to select the P 700 IQ on the measured value display.
- 5 Open the calibration and service menu with **<C>**.
The maintenance condition is activated.
- 6 Confirm the maintenance condition with **<OK>**.
The calibration and service menu is displayed.

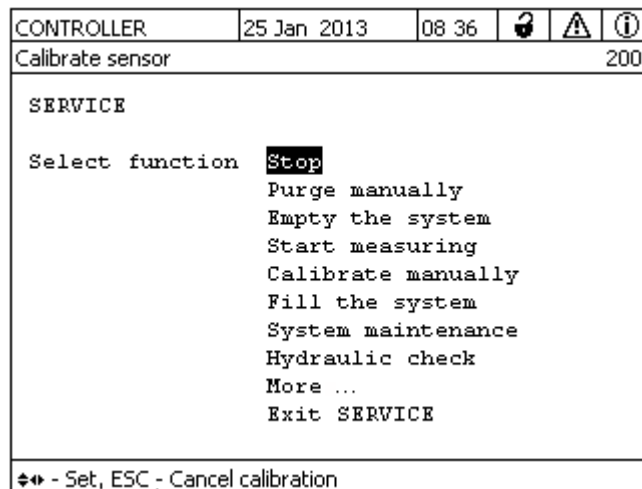

Fig. 4-7: Calibration and service menu

- 7 Carry out the *Stop* function to stop the running operation.
- 8 Option:
Carry out the *Purge manually* function to rinse the measuring cycle with cleaning solution.

Carrying out calibration

- 9 Carry out the *Calibrate manually / 2-point-cal.* function.
- 10 Follow the instructions on the display.



The order of the calibration standards is not important.

- 11 Calibrate with calibration standard 1.
 - 11.1 Connect calibration standard 1.
 - 11.2 Select calibration standard 1.
 - 11.3 Start the calibration procedure with **<OK>**.
- 12 Connect calibration standard 2 (see chapter 3.3.6 Connecting the lines, 38).
- 13 Calibrate with calibration standard 2.
 - 13.1 Connect calibration standard 2.
 - 13.2 Select calibration standard 2.
 - 13.3 Continue the calibration procedure with **<CONTINUE>**.

The calibration result is displayed after calibration standard 2 has been measured (*Calibration successful!*).



You have the following possibilities if the calibration failed:

- Repeat the calibration procedure (make sure that the correct calibration standard is connected and selected for calibration).
- Use the last valid calibration (see section 4.2.5 Reactivating the last valid calibration, 62)
- Use the factory calibration (see section 4.2.5 Reactivating the last valid calibration, 62)

Restarting measuring operation

- 14 If necessary, reconnect the calibration standard for automatic calibration.
- 15 Carry out the *Start measuring* function. Measurement is started and the measured value is displayed on the measured value display after approx. 5...7 minutes.
- 16 Carry out the *Exit SERVICE* function.
or
Exit the calibration and service menu with **<ESC>**.
- 17 Confirm the note with **<OK>**.
The measured value display appears. The measured value flashes.
- 18 If necessary, disconnect the terminal from the MIQ/WCA 232.
- 19 Close the housing of the P 700 IQ.
- 20 Wait until a measured value is shown on the measured value display (approx. 5...7 minutes).
- 21 Switch off the maintenance condition.
See the IQ SENSOR NET system operating manual.

Possible calibration results

The calibration data are evaluated by the system. A calibration procedure can have the following results:

Display after calibrating	Log book entries (meaning/actions)
Measured value	Successful calibration

"----"	<p>Sensor could not be calibrated. Sensor blocked for measurement.</p> <ul style="list-style-type: none"> • Carry out maintenance activities immediately (see operating manual). • View the calibration history. • Check the calibration conditions and calibration standard.
--------	--

4.2.4 Calibration history

Calibration history

CONTROLLER	25 Jan 2013	17 46			
Calibration history of selected sensor					330
501	P700IQ-PO4	13010001			
Date	Type	m	t	OK	
25.01.13 08:00	M	0.044 *	0.019	+	← Currently active calibration
24.01.13 08:00	M	0.044 *	0.019	+	← Chronological list of the last calibration procedures
Return ESC					

Fig. 4-8: P 700 IQ calibration history

The calibration history provides the following information:

- **Date** and time of the calibration
- **Type**
M = manual calibration,
A = automatic calibration,
F = factory calibration
- **m** (slope)
- * = 1-pt. cal (the slope has not been determined)
no* = 2-pt. cal (the slope has been determined)
- **t** (offset)
- Calibration evaluation:
 - +: Successful calibration.
The new calibration data are taken over for measurement.
 - -: Calibration unsuccessful.
Sensor blocked for measurement.

4.2.5 Reactivating the last valid calibration

If a manual calibration procedure is unsuccessful, the measuring operation can only be resumed after the manual calibration has been repeated or a valid calibration has been reactivated.

If an automatic calibration procedure is unsuccessful, the analyzer stops. To be able to measure again, you have to carry out a valid calibration procedure in the calibration and service menu, or to reactivate a valid calibration.

Thus you can immediately continue to measure if a calibration has failed or you suspect that the calibration conditions have not been optimally met.





Reactivating old calibration data is a temporary measure. Take into consideration that the sensor may provide incorrect measured values. Ensure the correct functioning of the sensor by checking and/or recalibrating it.

- 1 Use <▲▼> to select the P 700 IQ on the measured value display.
- 2 Use <C> to switch to the calibration and service menu. The maintenance condition is activated.
- 3 Confirm the maintenance condition with <OK>. The calibration and service menu is displayed.
- 4 Carry out the *Start measuring* function. A menu to select the last valid calibration or the factory calibration is displayed.
- 5 Select the last valid calibration or the factory calibration.
- 6 Carry out the *Exit SERVICE* function.
or
Exit the calibration and service menu with <ESC>.
- 7 Confirm the note with <OK>. The measured value display appears. The measured value flashes.
- 8 If necessary, disconnect the terminal from the MIQ/WCA 232.
- 9 Close the housing of the P 700 IQ.
- 10 Switch off the maintenance condition. See the IQ SENSOR NET system operating manual.
The measured value is displayed after approx. 5...7 minutes.

5. Maintenance and cleaning

5.1 Hazard warnings

Read the chapter 2. Safety, 17 before doing any maintenance work. This is important for your personal safety.

 WARNING	
	<p>Dangerous chemicals.</p> <p>Improper use of chemicals can cause damage to your health.</p> <p>Heed the following rules:</p> <ul style="list-style-type: none">• Read the labels of the chemical containers and follow the safety instructions• Wear protective equipment (lab coat, protective goggles, chemical resistant protective gloves)

5.2 Consumables, accessories, replacement parts

Only use original consumables and accessories.

Consumables

Type	Consumable	Order number
RE 2.5	Reagent 2.5 L	821999
CL 1.0	Cleaning solution 1.0L	821998
ST0.0	Standard 1.0 L (0.0 mg/l PO ₄ -P)	821971
ST1.6	Standard 1.0 L (1.6 mg/l PO ₄ -P)	821997
ST8.0	Standard 1.0 L (8 mg/l PO ₄ -P)	821996
ST20.0	Standard 1.0 L (20 mg/l PO ₄ -P)	821995
PT	Pump tube (photometer unit)	821993
T SET	Tubing set for the photometer unit Depending on the quality of the inlet and outlet of the cell: <ul style="list-style-type: none"> • Plastic screw connection • Small metal pipe 	821992B 821992

Tab. 5-1: Consumables

Accessories

Type	Accessories	Order number
WM	Wall mounting assembly for P 700 IQ	821989
SM	Stand mount for P 700 IQ	821991
RM	Rail mount for P 700 IQ	821988
FM adapter	Adapter for horizontal installation of the filter membrane module	821983
FM Case	Module housing	821973
M 1.5	Attachment for filtration for filter membrane module 1.5 m, chain, clamp	821986
M-EXT 1.5	Extension for attachment for filtration 1.5 m	821985
RL 10	Return tube, unheated, 10 m	821964
RL 115-10	Return tube, heated, 115 VAC, 10 m	821965
RL 115-2	Return tube, heated, 115 VAC, 2 m	821975
RL 115-20	Return tube, heated, 115 VAC, 20 m	821955
RL 2	Return tube, unheated, 2 m	821974
RL 20	Return tube, unheated, 20 m	821954
RL 230-10	Return tube, heated, 230 VAC, 10 m	821966
RL 230-2	Return tube, heated, 230 VAC, 2 m	821976
RL 230-20	Return tube, heated, 230 VAC, 20 m	821956
SL 10	Suction line incl. slide, unheated, 10 m	821977
SL 115-10	Suction line incl. slide and heat tracing, 230 VAC, 5 m	821979
SL 115-20	Suction line incl. slide and heat tracing, 115 VAC, 20 m	821959
SL 115-5	Suction line incl. slide and heat tracing, 115 VAC, 5 m	821981
SL 20	Suction line incl. slide, unheated, 20 m	821957
SL 230-10	Suction line incl. slide and heat tracing, 230 VAC, 10 m	821980
SL 230-20	Suction line incl. slide and heat tracing, 230 VAC, 20 m	821960
SL 230-5	Suction line incl. slide and heat tracing, 230 VAC, 5 m	821982
SL 5	Suction line incl. slide, unheated, 5 m	821978

Type	Accessories	Order number
FM	Filter membrane module (incl. membrane)	821987
Filter-CL	Cleaning container for filter	821984
FM-B	Replacement brush for FM	821968
ST-BT	Bottle cap with tube	821970
Filter REP P700IQ	Replacement filter for fan	821969
Filter	Filter membrane set (2 membranes)	821972

Tab. 5-2: Accessories

Detergent concentrates

The base solutions for chemical cleaning of the filter membrane can be purchased in household or specialist shops (for chemical cleaning, see chapter 5.4.6.2 Chemical cleaning, 92).

Household hygienic cleaners based on sodium hypochlorite

- Example: Dan Klorix, by Colgate-Palmolive GmbH
- Available in shops selling household goods, household departments of big shops and hardware stores etc.

Trade name: 9062 Sodium hypochlorite solution

- Order no.: 90620.3
- Carl Roth, Schoemperlenstraße 3, 76185 Karlsruhe

Trade name: Techn. sodium hypochlorite solution (approx. 13 % active chlorine)

- Order no.: 105614
- Merck KGaA, 64271 Darmstadt

5.3 Maintenance and cleaning activities (general steps)

5.3.1 General information

Maintenance activities have to be carried out at regular intervals on the P 700 IQ.

The preparation of the P 700 IQ depends on whether the maintenance activity should be carried out while the P 700 IQ is closed or open.

Maintenance activity	P 700 IQ	Interval
<i>Purge manually</i>	Closed	As required (see section 5.3.3, 72)
<i>Calibrate manually</i>		
Cleaning the filter membrane		2 ... 4 weeks depending on application (see section 5.4.6, 90)
Changing the filter membrane		If cleaning does not achieve any improvement (see section 5.4.7, 94)
Changing the liquid containers	Open (Overall: section 5.3.4, 74)	Approx. 4 months depending on the frequency of measurement, cleaning, cali- bration (see section 5.4.1, 77)
Changing the valve tubes (T SET)		12 months (see section 5.4.4, 81)
Changing the filter mats		Depending on contamination (see section 5.4.3, 80)
Changing the pump tube of the peristaltic pump		12 months depending on measuring interval (see section 5.4.5, 85)
Clean the overflow vessel		12 months (recommended) section 5.4.9, 95
Performing a <i>Hydraulic check</i>		When necessary section 5.4.11, 99
Performing a <i>LED Check</i>		When necessary section 5.4.12, 100

Tab. 5-3: Maintenance activities

5.3.2 Calibration and service menu (*SERVICE* menu)

All calibration and maintenance activities are controlled from the *SERVICE* menu. Prior to carrying out any maintenance work, the interval-controlled cleaning, calibration and measuring functions have to be stopped.

- 1 Use <▲▼> to select the P 700 IQ in the measured value display.
- 2 Use <C> to switch to the calibration and service menu.

Function	Description
<i>Stop</i>	<p>Immediately interrupts the running functions and prevents the next cleaning/calibration/measuring cycle from starting.</p> <p>Used in the following situations:</p> <ul style="list-style-type: none"> • Immediate switch-off of the P700IQ-PO4 • Maintenance activities
<i>Purge manually</i>	<p>Procedure to rinse the measuring cycle with cleaning solution (same procedure as automatic cleaning)</p> <p>Used in the following situations:</p> <ul style="list-style-type: none"> • Measured values are implausible • Maintenance activities were carried out on liquids, tubes or measuring cycle • Dirt is visible in the tubes <p>The manual and the automatic cleaning procedure do not clean the suction tubes of the sample and other liquids.</p>
<i>Empty the system</i>	<p>Procedure for the complete emptying of the inlet and outlet tubes of the connected liquids and the photometer unit.</p> <p>Used in the following situations:</p> <ul style="list-style-type: none"> • Decommissioning, shutdown, transport of the P 700 IQ • Repair and maintenance activities, e.g. changing the tubes.
<i>Start measuring</i>	<p>Procedure to start a measurement.</p> <p>The functionality of the photometer unit is unblocked. A first measurement is started.</p> <p>After the first measurement, further cleaning/calibration/measuring cycles will follow according to the specified intervals.</p> <p>Used in the following situations:</p> <ul style="list-style-type: none"> • Measuring operation is restarted (e.g. after maintenance activities) • To complete the initial commissioning
<i>Calibrate manually</i>	<p>Procedure to carry out a manual calibration (<i>1-point-cal.</i> or <i>2-point-cal.</i>)</p> <p>Used in the following situations:</p> <ul style="list-style-type: none"> • Measured values are implausible • Calibration result implausible • Maintenance activities were carried out on liquids, tubes or measuring cycle

Function	Description
<i>Fill the system</i>	<p>Procedure to fill all tubes with liquids and sample.</p> <p>Used in the following situations:</p> <ul style="list-style-type: none"> • The tubes are not filled completely (to the valve) with liquid, e.g. after exchanging the liquid containers • Air is in the tube
<i>System maintenance</i>	<p>Procedure to exchange containers (liquids):</p> <p>Sets the counter for the selected container to 100% and fills the relevant tubes. Selection:</p> <p><i>Replace reagent</i></p> <p><i>Replace standard</i></p> <p><i>Replace cleaning solution</i></p> <p><i>Replace all</i> (reagent, standard and cleaning solution)</p> <p><i>Return</i></p>
<i>Hydraulic check</i>	<p>After the <i>Hydraulic check</i> function has been started</p> <ul style="list-style-type: none"> • all 5 valves are activated one after the other • the motor of the pump is tested in 3 conditions (slowly forward, quickly forward, backward)
<i>LED Check</i>	<p>After the <i>LED Check</i> function has been started</p> <ul style="list-style-type: none"> • the blue measurement LED lights up and goes out 5 times for approx. 2 seconds each
<i>More . . .</i>	
<ul style="list-style-type: none"> • <i>Info</i> 	Displays the firmware version of the photometer unit.
<ul style="list-style-type: none"> • <i>Protected area</i> 	Menu for service personnel (password protected)
<ul style="list-style-type: none"> • <i>Return</i> 	One menu level higher
<i>Exit SERVICE</i>	<p>Exits the <i>SERVICE</i> menu.</p> <p>Alternative: Press the <ESC> key.</p>

Tab. 5-4: Menu *SERVICE*

5.3.3 Maintenance and cleaning work on the closed P 700 IQ

The following maintenance activities can be carried out remote-controlled with the P 700 IQ closed:

- *Purge manually*
- *Calibrate manually*

Maintenance interval

As necessary. Regular cleaning or calibration, see:

- *Autom. cleaning*
(section 4.1.4 Settings for the P 700 IQ, 51)
- *Autom. calibration*
(section 4.1.4 Settings for the P 700 IQ, 51)

Carrying out maintenance activities

Proceed as follows to carry out maintenance activities on the closed P 700 IQ:

Selecting the P 700 IQ

- 1 Use <▲▼> to select the P 700 IQ in the measured value display.

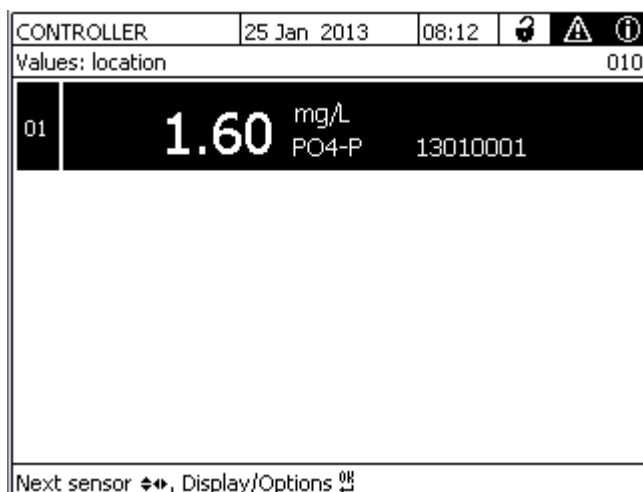

Fig. 5-1: Measured value display

Stopping the running operation

- 2 Use <C> to switch to the calibration and service menu. The maintenance condition is activated.
- 3 Confirm the maintenance condition with <OK>. The calibration and service menu is displayed.

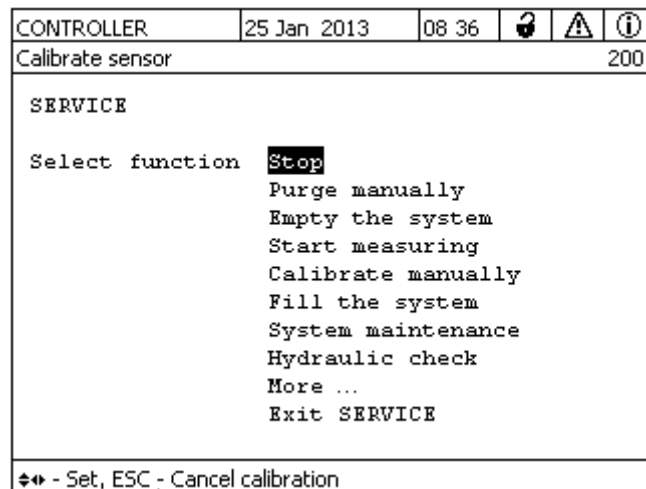

Fig. 5-2: Calibration and service menu

Carrying out maintenance activities

- 4 Carry out the *Stop* function to stop the running operation.
- 5 Carry out the required maintenance activities, such as:
 - Start the maintenance function in the calibration and service menu (*Purge manually, Calibrate manually / 1-point-cal.*)
Follow the instructions on the display.
After the maintenance function is finished, the calibration and service menu is displayed again.
 - Changing the filter mats
(see section 5.4.3 Changing the filter mats, 80)



Restarting the measuring operation

- 6 Carry out the *Start measuring* function. Measurement is started and the measured value is displayed on the measured value display after approx. 5...7 minutes.
- 7 Carry out the *Exit SERVICE* function.
or
Exit the calibration and service menu with **<ESC>**.
- 8 Confirm the note with **<OK>**. The measured value display appears. The measured value flashes.
- 9 Wait until a measured value is shown on the measured value display (approx. 5...7 minutes).
- 10 Switch off the maintenance condition. See the IQ SENSOR NET system operating manual.

5.3.4 Maintenance and cleaning work on the open P 700 IQ

The following maintenance activities have to be carried out manually while the P 700 IQ is open:

- Changing the liquid containers
- Changing the tube set (T SET)
- Changing the tube of the peristaltic pump
- Clean the overflow vessel
- Cleaning the suction tube
- Changing or cleaning the filter membrane

 WARNING	
	<p>Dangerous chemicals.</p> <p>Improper use of chemicals can cause damage to your health.</p> <p>Heed the following rules:</p> <ul style="list-style-type: none"> • Read the labels of the chemical containers and follow the safety instructions • Wear protective equipment (protective goggles, chemical resistant gloves)

Carrying out maintenance activities

Proceed as follows to carry out maintenance activities on the open P 700 IQ:

Opening the housing

- 1 Open the housing of the P 700 IQ.



Important for maintenance activities in the open:
If the ambient temperatures are below 0 °C, make sure that the liquids do not freeze while the maintenance activities are carried out. Leave the housing open for as short a time as possible.

Selecting the P 700 IQ

- 2 Use <▲▼> to select the P 700 IQ in the measured value display.

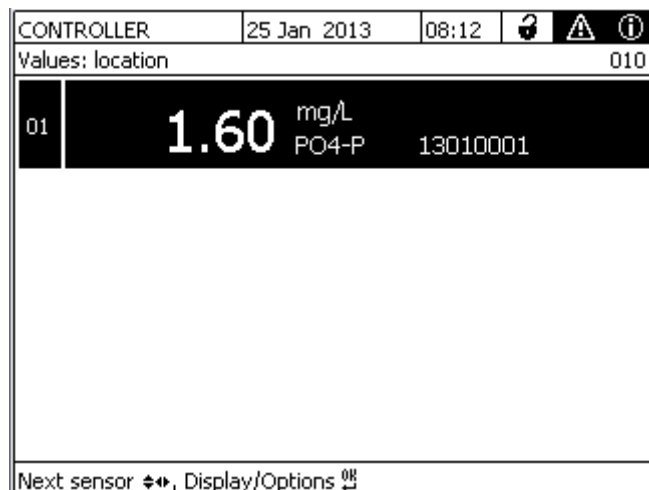

Fig. 5-3: Measured value display

Stopping running operation

- 3 Use <C> to switch to the calibration and service menu. The maintenance condition is activated.
- 4 Confirm the maintenance condition with <OK>. The calibration and service menu is displayed.

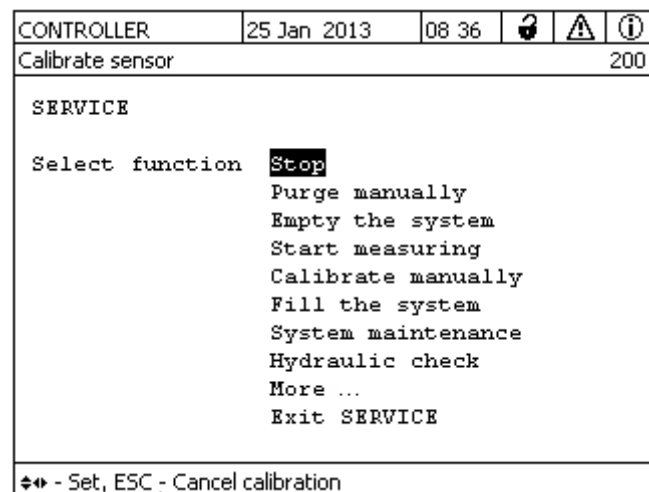

Fig. 5-4: Calibration and service menu

**If necessary,
Empty the system**

- 5 Carry out the *Stop* function to stop the running operation.
- 6 Carry out the *Empty the system* function for the following maintenance activities (otherwise, continue with step 12):
 - Change the valve tubes (T SET)
 - Changing the pump tube of the peristaltic pump
- 7 Follow the instructions on the display.
- 8 Place all intake tubes into deionized water.
- 9 Start the rinsing procedure.

- 10 After the rinsing, leave the intake tubes in air.
- 11 Carry out the *Empty the system* function once again. After the emptying is finished, the calibration and service menu is displayed again.
- 12 Carry out the required maintenance activities, such as:
 - Change the liquid containers
(see section 5.4.1, 77)
 - Change the valve tubes (T SET)
(see section 5.4.4 Changing the tube set (T SET), 81)
 - Changing the pump tube of the peristaltic pump
(see section 5.4.5, 85)
 - Clean the overflow vessel
(see section 5.4.9 Cleaning the overflow vessel, 95)
 - Change the filter membrane
(see section 5.4.7 Exchanging the filter membrane, 94)
 - Clean the filter membrane
(see section 5.4.6 Cleaning the filter membrane, 90)
 - Perform *Hydraulic check*
(see section 5.4.11 Performing a Hydraulic check, 99)
 - Perform *LED Check*
(see section 5.4.12 Performing an LED Check, 100)
- 13 If the *Empty the system* function was carried out:
Carry out the *Fill the system* function after the maintenance activities are finished. All valve tubes are automatically filled with the connected solutions and sample liquid.
- 14 Optional (as necessary):
Carry out the *Purge manually* function to rinse the measuring cycle with cleaning solution.
- 15 Carry out the *Start measuring* function. Measurement is started and the measured value is displayed on the measured value display after approx. 5...7 minutes.
- 16 Carry out the *Exit SERVICE* function.
or
Exit the calibration and service menu with **<ESC>**.
- 17 Confirm the note with **<OK>**. The measured value display appears. The measured value flashes.
- 18 If necessary, disconnect the terminal from the P 700 IQ.
- 19 Close the housing of the P 700 IQ.
- 20 Wait until a measured value is shown on the measured value display (approx. 5...7 minutes).
- 21 Switch off the maintenance condition. See the IQ SENSOR NET system operating manual.

Restarting the measuring operation

5.4 Carrying out the maintenance and cleaning activities

5.4.1 Changing the liquid containers

The P 700 IQ has an extra counter for each liquid container (from software version 2.13). The counter counts the consumption of the following procedures as soon as the function was started:

- Measuring
- Calibrating
- Cleaning

Other procedures that consume liquids are not counted (e.g. rinsing, filling).



The current status of the counters for the liquid containers can be output as log book messages (sensor settings /Status (P700IQ-PO4) /Transmit to log book).

The counter displays the remaining quantity as a percentage.

If the remaining quantity of a liquid is only approx. 10% of the capacity, a log book message is automatically issued.



The filling level can only be displayed correctly when the new container is full (filling level 100 %).

Replace the container before the liquid is used up.

Maintenance interval

Approx. 4 months, depending on the frequency of measurement, cleaning, calibration.

Preparations

- 1 Carry out steps 1... 11 in section 5.3.4 Maintenance and cleaning work on the open P 700 IQ,  74.
- 2 Put on protective clothing (lab coat, protective goggles, chemical resistant protective gloves).

Changing a container

- 3 In the *SYSTEM MAINTENANCE* menu, select the menu for the container to be exchanged.
- 4 Open the color-coded lid of the empty liquid container without disconnecting the tube connection.

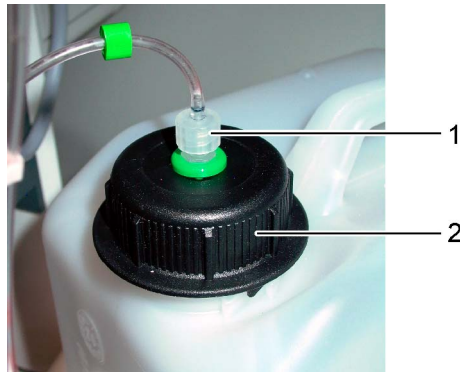

Fig. 5-5: Exchanging the liquid container

- 1 Tube connection (do not open)
2 Pre-installed, color-coded lid

- 5 Remove the empty liquid container.
- 6 Place the new liquid container in the collecting tray.
- 7 Make sure that the color-coding of the lid agrees with that of the container.
 - Reagent (green)
 - Cleaning solution (blue)
 - Standard solution (orange)
- 8 Open the new liquid container and screw the lid on the new container.



Keep the original lids of the liquid containers.

- 9 Close the empty liquid container with the stored lid.
- 10 After the container has been exchanged, confirm the question in the *Actions completed?* menu with *Yes*. The counter for the selected liquid is set to 100%. The tube for the selected liquid is filled.
- 11 Carry out steps 15...21 in section 5.3.4 Maintenance and cleaning work on the open P 700 IQ, 74.

Restarting the measuring operation

5.4.2 Checking the climate kit (if available)

Check in particular that the temperature in the inside of the housing is reliably regulated to the operating temperature (+15 °C...+40 °C) prior to impending periods of frost or heat (e.g. during autumn or during spring).

Functioning of the climate kit

Temperature (T) in the inside of the housing	Description
T < +15 °C	A thermostat switches on a heating fan and a circulation fan. Warm air is created and distributed in the housing.
T > +25 °C	Heating fan and circulation fan are switched off
T > +35 °C	A thermostat switches on the ceiling fan Warm air is transported outside via the ventilation grid under the housing lid. Fresh ambient air is taken in via the ventilation grid on the connection plate in the bottom of the housing.
T < +25 °C	The ceiling fan is switched off.

Checking the climate kit

- 1 Check the logbook of the P 700 IQ for exceeding or undercutting the operating temperatures (chapter 8.1.1 Error messages,  115).

Checking the heating

- 2 At outside temperatures of < +10 °C, check that the heating ventilator is running:
Hold a hand to the upper edge of the white mounting plate (approximately in the middle).
Feel the warm air of the heating fan.
- 3 At outside temperatures of < +10 °C, check that the circulation fan is running:
Hold a hand to the left next to the chemical bottles.
Feel the air current from the ventilation grid (on the back of the white mounting plate) to the chemical bottles.



The air currents can be felt better with damp hands.

- 4 At outside temperatures of < +10 °C, check that the heating fan and circulation fan switch on:
To do so, open the housing doors until the fans switch on.



For temperatures below +15 °C, the measurement values can be too low.
Frost damage can occur at temperatures below 0 °C.

- Checking the cooling**
- 5** At outside temperatures of $> +35\text{ }^{\circ}\text{C}$, check that the ceiling fan is running:
 Open the housing lid.
 Hold a hand to the ventilation grid.
 Feel the air current.



The air currents can be felt better with damp hands.

For a (very) weak air current:
 Check the permeability of the filter mats (chapter 5.4.3
 Changing the filter mats, 80).

5.4.3 Changing the filter mats

The ventilation grids are under the housing lid and on the underside of the housing. The ventilator is behind a protective grating. Thus the filter mat can be exchanged without risk even during operation.

Maintenance interval Depending on contamination

- Upper ventilation grid**
- 1** Remove both front screws on the housing lid.
- 2** Open the housing lid upward and fix it with the bearer. See Fig. 5-6, 80.



Fig. 5-6: Opening the housing lid

- 1 Housing lid
 2 Bearer
 3 Fixing screw

- 3** Open the ventilation grid with the aid of a screwdriver by levering it off and exchange the filter mat. See Fig. 5-7, 81.

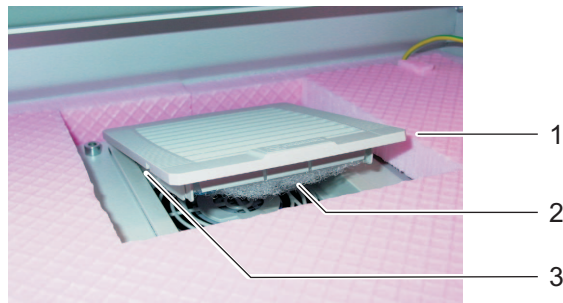

Fig. 5-7: Exchanging the upper filter mat

- 1 Ventilation grid
- 2 Filter mat
- 3 Opening for screwdriver

- 4 Close the ventilation grid.
- 5 Fold the bearer and close the housing lid.
- 6 Screw the housing lid tight with the two screws.

Lower ventilation grid

- 7 Position yourself under the analyzer housing.
- 8 Open the ventilation grid and exchange the filter mat as for the upper ventilation grid.



Fig. 5-8: Exchanging the lower filter mat

- 1 Ventilation grid
- 2 Filter mat

- 9 Close the ventilation grid.

5.4.4 Changing the tube set (T SET)

The tubes of the P700IQ-PO4 should be exchanged yearly.

The tube set (T SET) contains the following tubes:

Tube length (mm)	Color coding	Connection of	Tube ends
35		V7 NC - V8 NC	2 reinforced
35		VK 6C - V11 NO	2 reinforced
35		VK5 NC - V7 C	2 reinforced
35		VK5 C - pump	1 reinforced
50		V7 NO - V11 C	2 reinforced
110		Cell (plastic connection) - pump	1 nut
140		Cell (plastic connection) - V8 C	1 nut 1 reinforced
120 + 400		Sample tube 400 mm - sample	1 luer
		V11 NC - sample tube 120 mm	1 reinforced 1 luer
400	Green (reagent)	VK5 NO - reagent	1 reinforced 1 luer
400	Orange (calibration standard)	VK6 NO - calibration standard	1 reinforced 1 luer
400	Blue (cleaning)	VK6 NC - cleaning solution	1 reinforced 1 luer
500		V8 NO - waste container	1 reinforced

*Tab. 5-5: Tubes of the T-SET (order no 821992B)
for photometer unit with plastic connectors*

Maintenance interval 12 months

- Preparations**
- 1 Carry out steps 1 ... 11 in section 5.3.4 Maintenance and cleaning work on the open P 700 IQ,  74.
 - 2 Disconnect the plug from the P700IQ-PO4 (the heat tracing continues to operate).
or
Switch off the analyzer at the power switch.
 - 3 Screw off the empty photometer unit.
 - 4 Carry out the mounting work on a lab table.
 - 5 Remove the plastic cover from the photometer unit.

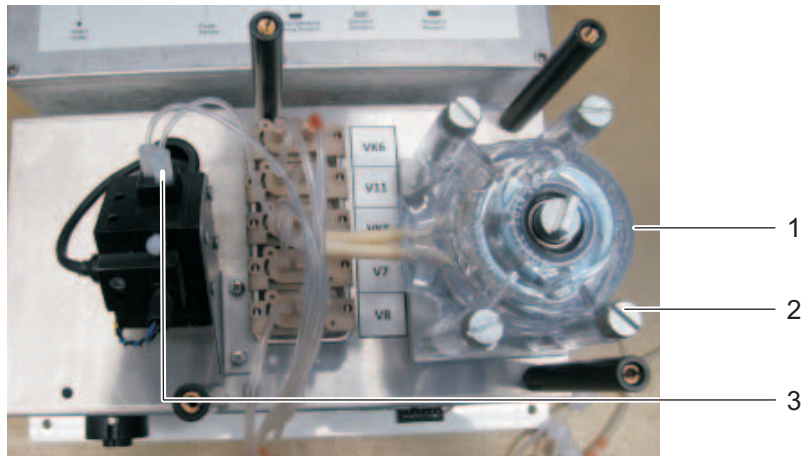

Fig. 5-9: Photometer unit without plastic cover

- 1 Peristaltic pump
- 2 Knurled-head screw
- 3 Cuvette

- 6 Put on protective clothing (lab coat, protective goggles, chemical resistant protective gloves).

Exchanging the tube set

- 7 Remove the old tubes.
- 8 Connect the replacement tubes according to the following connection diagrams:

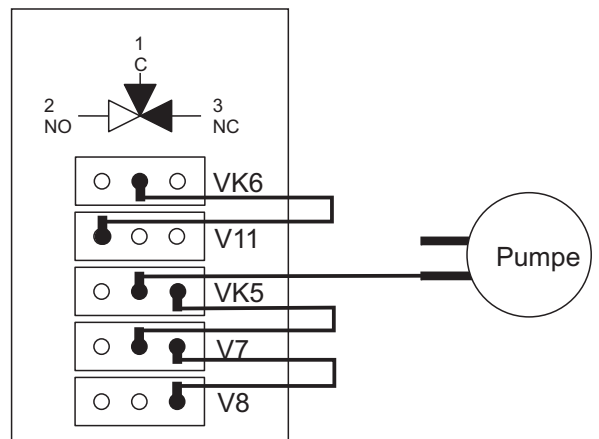

Fig. 5-10: Connection diagram for tubes with 35 mm length

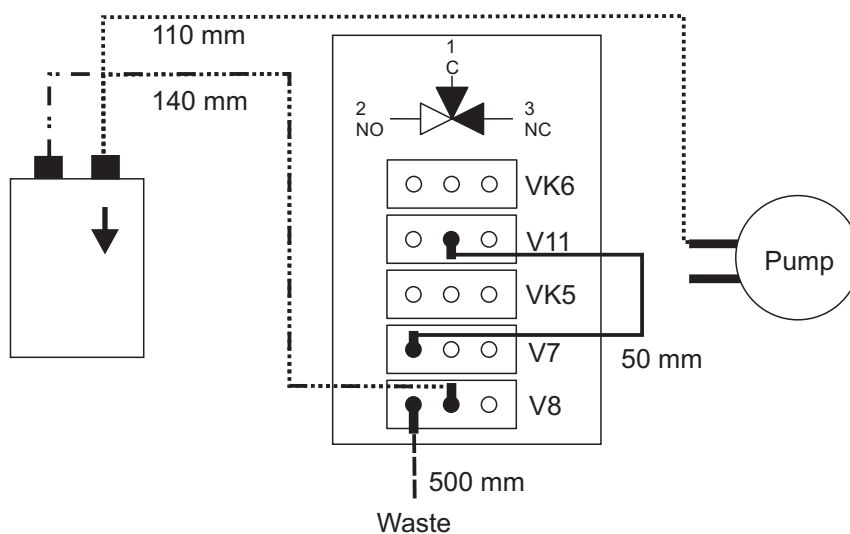

Fig. 5-11: Connection diagram for tubes with 50 mm, 110 mm, 140 mm, 500 mm length

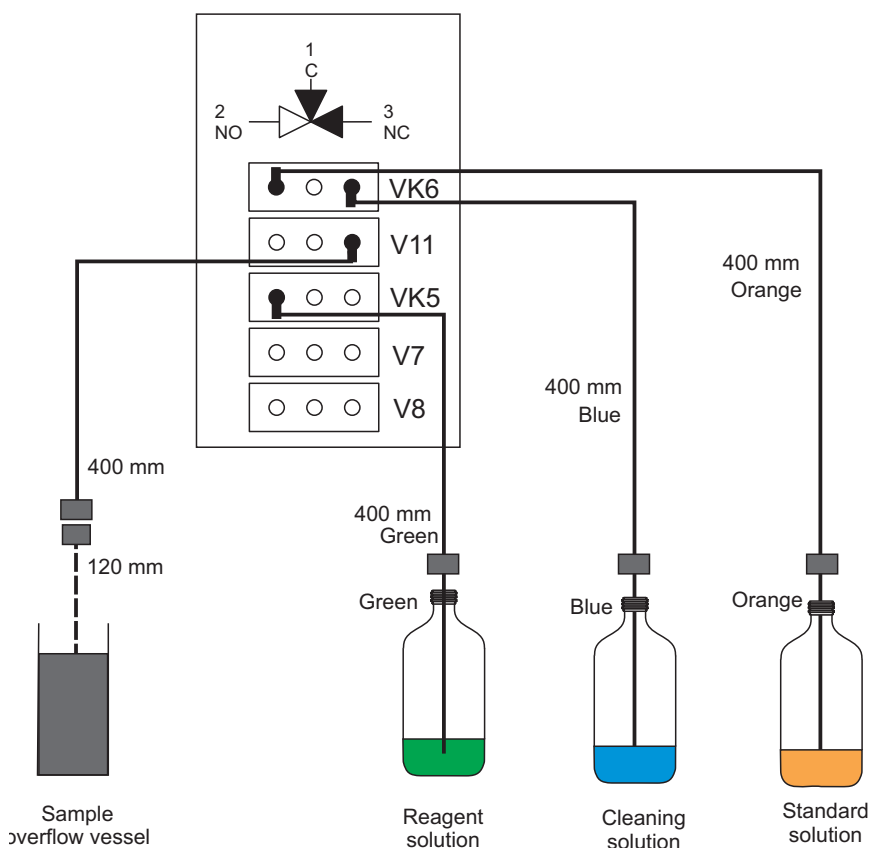



Fig. 5-12: Connection diagram for tubes with 400 mm and 400+120 mm length

- 9 Remount the plastic cover of the photometer unit.
- 10 Reconnect the plug with the P700IQ-PO4.
or
Switch on the analyzer again at the power switch.

Restarting the measuring operation

- 11** Carry out steps 13...21 in section 5.3.4 Maintenance and cleaning work on the open P 700 IQ,  74.

5.4.5 Changing the pump tube of the peristaltic pump

How it functions

The liquids are pumped through the P 700 IQ with the aid of a peristaltic pump.

A peristaltic pump is a displacement pump for the pumping of liquids. The liquid is in a flexible tube that is fitted in a circular pump housing. A rotor with several rolls presses down some parts of the flexible tube. When the rotor is turning, the rolls transport the liquid through the tube.

- The pump tube has a working life of 1500 hours for water. The chemicals used may, however, reduce the working life.
- The deterioration of the tube quality is a slow process. When the working life of the pump tube is near its end, the P 700 IQ may have to be calibrated more often.
- A peristaltic pump can be blocked when it is not used for a longer period of time because the parts of the flexible tube that are pressed down stick together. After a shutdown of several weeks, the blockage is normally cleared after some rotations. After a shutdown of several months, the flexible tube has to be removed and the blockage cleared by hand.

Maintenance interval

12 months

Parts required

- Pump tube PT (see chapter 7. Technical data,  107)
- Mounting aid

Preparations

- 1** Carry out steps 1... 11 in section 5.3.4 Maintenance and cleaning work on the open P 700 IQ,  74.
- 2** Put on protective clothing (lab coat, protective goggles, chemical resistant protective gloves).
- 3** Disconnect the plug from the P700IQ-PO4 (the heat tracing continues to operate).
or
Switch off the analyzer at the power switch.
- 4** Screw off the empty photometer unit.
- 5** Carry out the mounting work on a lab table.

6 Remove the plastic cover from the photometer unit.

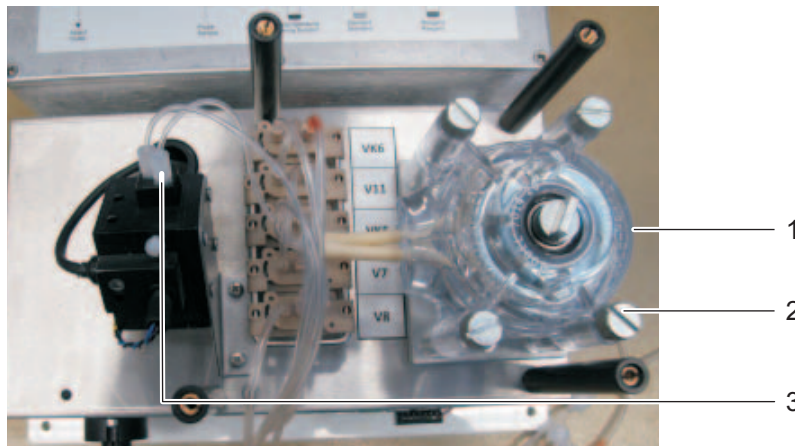

Fig. 5-13: Photometer unit without plastic cover

- 1 Peristaltic pump
- 2 Knurled-head screw
- 3 Cuvette

⚠ WARNING	
	<p>Dangerous chemicals.</p> <p>If the pump tube was leaky or has burst, chemicals may have leaked. Improper handling of chemicals can cause damage to your health.</p> <p>Heed the following rules:</p> <ul style="list-style-type: none"> • Read the labels of the chemical containers and follow the safety instructions • Wear protective equipment (lab coat, protective goggles, chemical resistant protective gloves)

Dismounting the pump

- 7 Remove the four knurled-head screws that fix the pump head in place.
- 8 Disconnect the connections at both ends of the pump tube.
- 9 Pull the pump head off the pump power unit. When doing so, and during the next step, make sure that the rotor of the pump head does not fall out. It sits loosely in the pump head.
- 10 Separate the two halves of the pump head from each other.
- 11 Remove the used pump tube (PT).

Replacing the pump tube

- 12 Take one half of the pump head into your hands. See Fig. 5-14, 87.



Fig. 5-14: Holding one half of the pump head (tube openings are on the left side)

- 13 Lift the new pump tube (PT) to discover its intrinsic bend. See Fig. 5-15, 87.

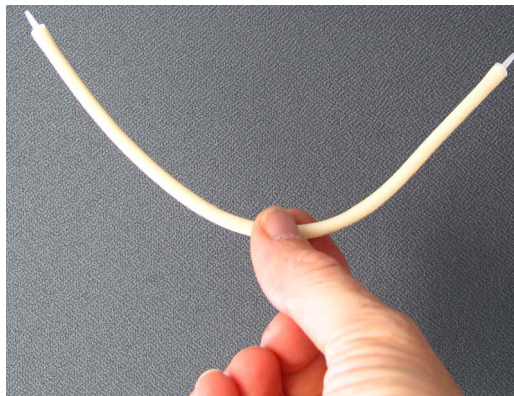

Fig. 5-15: Intrinsic bend of the tube



All tubes have an intrinsic bend. Always equip the pump in accord with the intrinsic bend of the tube.

- 14 Insert the new tube in the dent so that it touches the two rear rolls. Hold the end of the tube with your thumb in the dent. See Fig. 5-16, 87.



Fig. 5-16: Inserting the tube in the dent

- 15 Insert the mounting aid (included in the scope of delivery) between the rotor plate and the hose. See Fig. 5-17, 88.

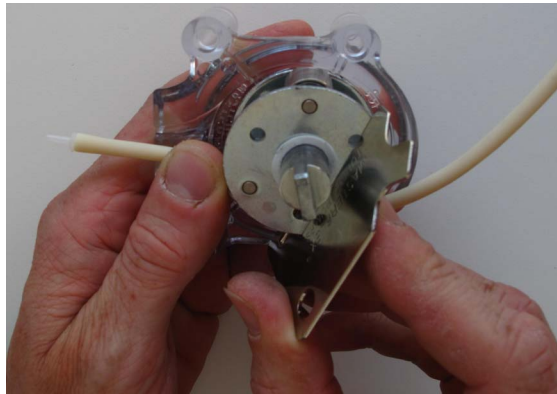

Fig. 5-17: Inserting the mounting aid

- 16 Push the mounting aid completely inside. The mounting aid presses the tube into the dent.
- 17 Turn the mounting aid counterclockwise while holding the tube with your thumb. See Fig. 5-18, 88.
- 18 Continue until the tube is completely around the rotor.

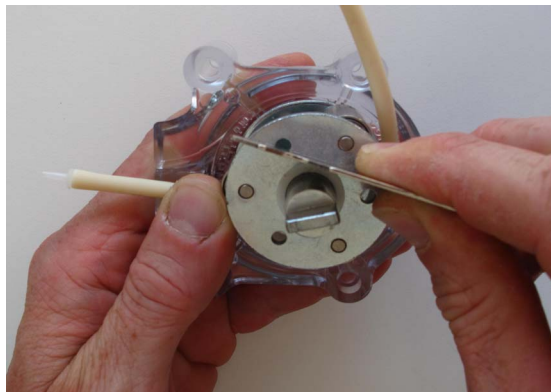

Fig. 5-18: Turning the mounting aid anticlockwise

- 19 Hold both ends of the tube with your thumb and remove the mounting aid. See Fig. 5-19, 88.



Fig. 5-19: Removing the mounting aid

- 20** The tube is now in the dent. See Fig. 5-20, 89.



Fig. 5-20: Pump tube in the dent

- 21** Place the second half of the pump head on the motor shaft. See Fig. 5-21, 89.

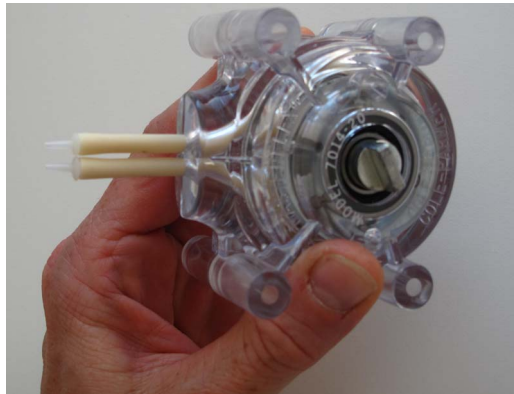

Fig. 5-21: Positioning the upper part of the pump head

- 22** Align the two halves of the pump head and then press them together. See Fig. 5-22, 89.
Make sure that the tube is not pinched between the two halves.

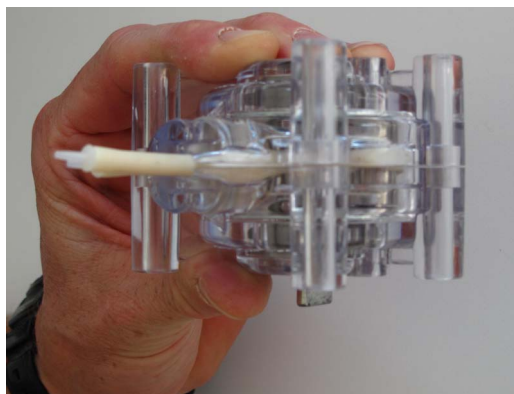



Fig. 5-22: Pressing together the two halves of the pump head

Mounting the pump

- 23** Position the pump head on the pump drive in the analyzer.

Restarting the measuring operation

- 24 Turn the roll block on the pump head until it agrees with the spindle on the pump drive.
- 25 Screw in the four knurled-head screws and tighten them step by step and crosswise.
- 26 Connect both ends of the pump tube. See Fig. 5-13,  86.
 - The upper end of the tube goes to the cell of the optical block
 - The lower end of the tube goes to the center connection of V5
- 27 Remount the plastic cover of the photometer unit.
- 28 Reconnect the plug with the P700IQ-PO4.
or
Switch on the analyzer again at the power switch.
- 29 Carry out steps 13...21 in section 5.3.4 Maintenance and cleaning work on the open P 700 IQ,  74.
- 30 Make sure that the liquids run through the tubes in the correct direction and that all tube connections are tight.

5.4.6 Cleaning the filter membrane

When to clean the filter membrane can be determined empirically based on the negative pressure display on the filtration pump.

- A pulsing negative pressure manometer suggests a normal operating condition of the filtration unit
- With a delivery height of approx. 2 m and a new filter membrane, the negative pressure is approx. -0.3 bar.
Every meter of delivery height increases the negative pressure by approx. -0.1 bar.
If the negative pressure increases by a further -0.3 ... -0.4 bar with time, the membrane is covered with solid matter from the sample and has to be cleaned.
- If there is still negative pressure after cleaning, the suction line may possibly be blocked.



The mechanical or chemical cleaning of the filter membrane may take some time.

Use a replacement filter membrane module (FM) during the cleaning process to keep the downtime of the analyzer as short as possible.

Prior to starting the cleaning process, switch off the filtration pump (with the Start/Stop key, or switch off the whole analyzer).

ATTENTION	
	<p>Do not remove the filter membrane insert from the PVC housing, as the membrane surface adheres to the seals and is normally damaged when removed. If the filter membrane is dismantled, inevitably it must also be replaced.</p> <p>The filter membrane is easily damaged. Never touch the membrane with sharp-edged objects or place any objects on it.</p> <p>Pressure on the filter membrane must only be applied from the outside. No counterpressure may build up through the suction line.</p>

The filter membrane can be cleaned either mechanically or chemically.



Prior to removing or plugging in the sample tube, clean it with clear water and a cloth, for example.

Dirt particles in the sample flow can block the valves of the photometer unit.

Maintenance interval 2 to 4 weeks, depending on application

5.4.6.1 Mechanical cleaning

- | | |
|---------------------|--|
| Preparations | <ol style="list-style-type: none"> 1 Carry out steps 1 ... 11 in section 5.3.4 Maintenance and cleaning work on the open P 700 IQ,  74. 2 Switch off the filtration pump (with the Start/Stop key, or switch off the whole analyzer). 3 Pull the filtration unit out of the basin or channel. <ul style="list-style-type: none"> • The filter membrane module does not have to be separated from the guide slide. • Do not remove the filter membrane from the PVC housing. 4 Rinse off any coarse contamination with low water pressure (e.g. with a watering can or wash bottle). 5 Then carefully remove the coating from the filter membrane using a soft special brush. Normally it is easy to see the brownish coating coming off while the lighter membrane surface appears. |
|---------------------|--|



ATTENTION

Do not press the special brush too firmly on the membrane surface and do not change the moving direction of the brush (do not scrub!).

- 6 After cleaning, check both sides of the membranes for damage.
- 7 Thoroughly clean the special brush under running water, dry it and store in a dust free place until the next use.
- 8 Submerge the cleaned filter membrane module in the basin or channel.
- 9 Switch on the filtration pump with the Start/Stop key.
- 10 Carry out steps 15...21 in section 5.3.4 Maintenance and cleaning work on the open P 700 IQ, 74.

Restarting the measuring operation

5.4.6.2 Chemical cleaning

Chemical cleaning is recommended if mechanical cleaning no longer brings any significant improvement, i.e. the negative pressure set on the manometer no longer reduces significantly after mechanical cleaning.

The filter membrane is then blocked. The blockage is mainly of an organic nature and can only be removed by chemical cleaning.

The chemical cleaning is carried out with the aid of a suitable container (Filter-CL) for the cleaning bath. The amount of cleaning solution required depends on the shape and size of the cleaning container.

Cleaning solution

In most cases, organic blockages can easily be removed with an aqueous sodium hypochlorite solution (chlorine bleaching agent, NaClO, 1 % active chlorine). In individual cases, NaOH 4 % (sodium hydroxide) has also been effective.



In the event of calcification, diluted hydrochloric acid (HCl) is recommended (0.01 mol/l HCl, 0.036%, pH 2).

Preparing the cleaning solution

The membrane cleaner can be made from different detergent concentrates by diluting with water. A selection of possible detergent concentrates is given in the section 5.2 Consumables, accessories, replacement parts, 65.

Prepare the cleaning solution according to the following table. It can be mixed in the cleaning container.

Base solution	Preparation instructions	Yield
Household hygienic cleaner based on sodium hypochlorite	Add sufficient water to 1.5 l hygienic cleaner so that the volume is 6 l	6 l
Techn. sodium hypochlorite solution (13 % active chlorine)	Add sufficient water to 300 ml solution that the volume is 5 l	5 l

 WARNING	
	<p>Dangerous chemicals.</p> <p>Improper use of chemicals can cause damage to your health.</p> <p>Heed the following rules:</p> <ul style="list-style-type: none"> • Read the labels of the chemical containers and follow the safety instructions • Wear protective equipment (lab coat, protective goggles, chemical resistant protective gloves)

Pre-cleaning

- 1 Prior to each chemical cleaning, pre-clean the membrane with the special brush and rinse it with water. See section 5.4.6.1 Mechanical cleaning, 91.

Chemical cleaning

- 2 Dismount the filter membrane module from the slide.
- 3 Completely submerge the filter module with the installed filter membrane in the cleaning container filled with the membrane cleaner.
 - Start with a reaction time of 30 minutes.
 - Monitor the success of the cleaning and extend the reaction time as necessary.
- 4 After the chemical cleaning, rinse the filter membrane module with clean water.



Even membranes that are supposedly irreversibly blocked may be restored by leaving them in the cleaning solution for a longer period of time and then rinsing them several times.

Restarting operation

- 5 Remount and secure the cleaned filter membrane module on the slide.
- 6 Submerge the filtration unit in the basin or channel.

Restarting the measuring operation

- 7 Switch on the filtration pump with the Start/Stop key.
- 8 Leave the filtration pump to work for some time to completely remove the detergents from the filter membrane and suction tube.
- 9 Carry out steps 13...21 in section 5.3.4 Maintenance and cleaning work on the open P 700 IQ,  74.

5.4.7 Exchanging the filter membrane

	ATTENTION
	<p>If the filter membrane is dismantled, inevitably it must also be replaced.</p> <p>The filter membrane is easily damaged. Never touch the membrane with sharp-edged objects or place any objects on it.</p>

Maintenance interval

As necessary if cleaning does not help.

Proceed as follows to exchange the filter membrane:

Preparations

- 1 Carry out steps 1...11 in section 5.3.4 Maintenance and cleaning work on the open P 700 IQ,  74.
- 2 Switch off the filtration pump (with the Start/Stop key, or switch off the whole analyzer).
- 3 Remove the filtration unit from the medium.
- 4 Clean the filtration unit.
- 5 Dismount the filter membrane module from the slide.
- 6 Unscrew the V4A countersunk screws of the fixing ring (12 hexagon sockets).
- 7 Remove the used filter membrane.
- 8 Clean the housing and seals.
- 9 Check that the housing seals are correctly positioned and grease them slightly.
- 10 Insert a new filter membrane in the lower part of the housing.

- | | |
|---|---|
| Restarting the measuring operation | <ul style="list-style-type: none"> 11 Place the fixing ring on the lower part of the module housing with the installed filter membrane. 12 Insert the V4A countersunk screws and tighten them by hand. The fixing ring and lower part of the housing must be pressed together and flush (without gap). 13 Remount and secure the cleaned filter membrane module on the slide. 14 Submerge the filtration unit in the basin or channel. 15 Switch on the filtration pump with the Start/Stop key. |
| | <ul style="list-style-type: none"> 16 Carry out steps 13...21 in section 5.3.4 Maintenance and cleaning work on the open P 700 IQ,  74. |

5.4.8 Storing a used filter membrane

Proceed as follows to store the filter membrane:

- 1 Mechanically clean the filter membrane.
- 2 Chemically clean the filter membrane.
- 3 Rinse the filter membrane under flowing tap water.
- 4 To protect against drying out, store the filter membrane in the Filter-CL cleaning container or in a sealed plastic bag.



Prior to each use, soak the filter membrane in tap water. If the filter membrane has dried out, soak it for several hours in tap water.

5.4.9 Cleaning the overflow vessel

Maintenance interval As required.

Proceed as follows to clean the overflow vessel:

- | | |
|---------------------|--|
| Preparations | <ol style="list-style-type: none"> 1 Carry out steps 1...11 in section 5.3.4 Maintenance and cleaning work on the open P 700 IQ,  74. 2 Switch off the filtration pump (with the Start/Stop key, or switch off the whole analyzer). 3 Keep a container ready to collect the contents of the overflow vessel. |
|---------------------|--|

- 4 Open the sample intake tube at the quick coupling on the overflow vessel and let the contents of the overflow vessel drain into the container.
 - 5 Clean the overflow vessel with a brush, water, descaler or detergent. Subsequently, thoroughly rinse the overflow vessel with water to remove any detergent residues.
 - 6 Reconnect the sample intake tube to the quick coupling of the overflow vessel.
 - 7 Switch on the filtration pump with the Start/Stop key.
 - 8 Leave the filtration pump to work for some time to completely remove the detergents.
- Restarting the measuring operation**
- 9 Carry out steps 13...21 in section 5.3.4 Maintenance and cleaning work on the open P 700 IQ, 74.

5.4.10 Cleaning the suction tube of the sample filtration

The suction tube brings the sample from the filter membrane module to the overflow vessel via the filtration pump. From time to time it can be required to clean the suction tube.

Fig. 5-23, 96 shows the suction tube (blue, ID 2mm; OD 4 mm) in the analyzer P 700 IQ.



Fig. 5-23: Filtration pump with suction tube

1 Suction tube of the sample filtration

Fig. 5-24, 97 shows the suction tube on a mounted filter membrane module in a sedimentation tank.



Fig. 5-24: Sample filtration device (installed)



- 1 Suction tube
- 2 Sleeve tube of the suction line

	WARNING
	<p>Dangerous chemicals.</p> <p>Improper use of chemicals can cause damage to your health.</p> <p>Heed the following rules:</p> <ul style="list-style-type: none"> Read the labels of the chemical containers and follow the safety instructions Wear protective equipment (lab coat, protective goggles, chemical resistant protective gloves)

Maintenance interval As required.



Proceed as follows to clean the suction tube:

- Preparations**
- 1 Carry out steps 1 ... 11 in section 5.3.4 Maintenance and cleaning work on the open P 700 IQ, 74.
 - 2 Switch off the filtration pump (with the Start/Stop key, or switch off the whole analyzer).
 - 3 Keep a container ready to collect the contents of the overflow vessel.
 - 4 Open the sample intake tube at the quick coupling on the overflow vessel and let the contents of the overflow vessel drain into the container.

- 5 Clean the overflow vessel with a brush, water, descaler or detergent. Subsequently, thoroughly rinse the overflow vessel with water to remove any detergent residues.
- 6 If necessary: Clean the filter membrane (see section 5.4.6 Cleaning the filter membrane,  90)
- 7 Disconnect the suction tube from the filter membrane module and put it in a container with cleaning solution (recommendation: see section 5.2 Consumables, accessories, replacement parts,  65).
For the minimum quantity of cleaning solution for the different tube lengths, see the following table:

Suction tube length	Minimum quantity of cleaning solution
5 m	≥ 30 ml
10 m	≥ 50 ml
20 m	≥ 100 ml

- 8 Insert the sample intake tube coming from the filtration pump in a bottle (≥ 0.5 l) or another suitable container and fix it.

 WARNING	
	<p>Dangerous chemicals. Wear protective equipment (lab coat, protective goggles, chemical resistant protective gloves)</p> <p>Risk of splashing!</p> <p>During operation, the filtration pump can develop considerable pressure. Therefore, absolutely heed the following instructions:</p> <ul style="list-style-type: none"> • Fix the sample intake tube so that the pressure surges of the filtration pump will not make it come out of the bottle. • Cover the bottle so that no cleaning solution can splash out due to the pressure surges. • Bring the bottle into the stable position and fix it if necessary. • If necessary, test the arrangement with tap water first !

- 9 Switch on the filtration pump with the Start/Stop key so cleaning solution is intaken through the suction tube until it runs into the bottle at the open tube end. This is achieved when the minimum quantity (see table step 7) is intaken from the container with cleaning solution. If necessary, increase the percent setting for the pump performance at the filtration pump.

- 10 Switch off the filtration pump with the Start/Stop key, allow the cleaning solution to take effect (altogether approx. 10 min). During this time, occasionally start/stop the filtration pump so the cleaning solution in the suction tube is moved towards the bottle.
 - 11 When doing so, check the filling level of the bottle to keep the solution from overflowing. If necessary, empty the bottle (dispose of the cleaning solution properly).
 - 12 Switch on the filtration pump with the Start/Stop key.
 - 13 Reconnect the suction tube to the filter membrane module and reinstall the filter membrane module in the sample.
 - 14 Switch on the filtration pump with the Start/Stop key and let it pump for some time (at least 5 - 10 min, depending on the length of the suction tube) with approx. 60% pump performance to completely remove all the cleaning solution from the filter membrane and suction tube. This can normally be recognized by the clear sample liquid that comes out of the tube. If necessary, set the percent setting for the pump performance to the previous value.
 - 15 Switch off the filtration pump with the Start/Stop key.
 - 16 Reinstall the sample intake tube coming from the filtration pump at the quick coupling on the overflow vessel.
 - 17 Remove the container that held the cleaning solution. Dispose of the cleaning solution in the bottle properly.
- Restarting the measuring operation**
- 18 Carry out steps 13...21 in section 5.3.4 Maintenance and cleaning work on the open P 700 IQ, 74.

5.4.11 Performing a *Hydraulic check*

You can check the functioning of the valves and pump.
After the *Hydraulic check* function has been started

- all 5 valves are activated once one after the other
- the pump is tested in 3 conditions (slowly forward, quickly forward, backward)

Thus you can check the functioning of the valves and pump on the open P 700 IQ.

Maintenance interval As necessary

Preparations 1 Carry out steps 1 ... 11 in section 5.3.4 Maintenance and cleaning work on the open P 700 IQ,  74.

2 Start the *Hydraulic check* function. All valves are activated once.



The order in which the valves are checked is indicated on the display:

HYDRAULIC CHECK

Cycle:

V8 (on/off) - V7 (on/off) - VK5 (on/off) - V11 (on/off) - VK6 (on/off) - pump (forward slowly) - pump (forward fast) - pump (backwards)

Performing the check

3 Count the number of switching noises.
You will hear 10 switching noises if all valves are working.

4 Count the number of pump movements.
You will see 3 pump movements if the pump is working OK.



If a valve or the pump does not work:

- Decommission the P 700 IQ.
- Contact the service department.

Restarting the measuring operation

5 Carry out steps 15 ... 21 in section 5.3.4 Maintenance and cleaning work on the open P 700 IQ,  74.

5.4.12 Performing an *LED Check*

You can check the functioning of the measurement LED on the open P 700 IQ.

The blue measurement LED is at the bottom of the photometer unit inside the LED holder collecting the black and blue connection cables for the measurement LED (see section Fig. 5-25: Photometer unit during LED check,  101). After the *LED Check* function was started, the measurement LED lights up and goes out 5 times for approx. 2 seconds each.

Maintenance interval

As necessary

Preparations

1 Carry out steps 1 ... 11 in section 5.3.4 Maintenance and cleaning work on the open P 700 IQ,  74.

- 2 In the calibration and service menu, select *More . . .*, then the *LED Check* function.
- 3 Start the *LED Check* function.



LED CHECK

Cycle:

LED (on/off) - LED (on/off) - LED (on/off) - LED (on/off) - LED (on/off)

Performing the check

- 4 From below look up into the LED holder collecting the black and blue connection cables for the measurement LED (see section Fig. 5-25: Photometer unit during LED check, 101). The blue measurement LED is inside the LED holder. Watch the LED.
- 5 Check whether the LED lights up and goes out. If the LED functions, it lights up and goes out 5 times for approx. 2 seconds each.

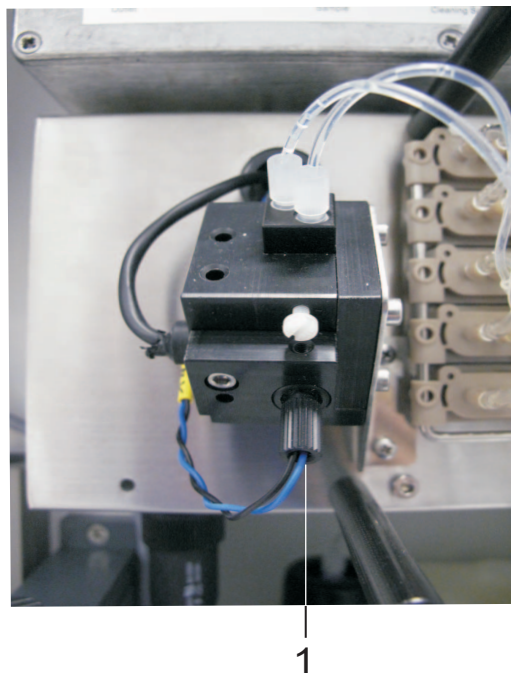

Fig. 5-25: Photometer unit during LED check

1 LED holder with black and blue connection cables for the measurement LED



In measuring operation, the measurement LED lights up only temporarily. In other operating modes, however, it may also light up for longer periods of time, depending on the operating situation.



If the LED does not light up at all or does not light up as described:

- Decommission the P 700 IQ.
- Contact the service department.

Restarting the measuring operation

- 6 Carry out steps 15...21 in section 5.3.4 Maintenance and cleaning work on the open P 700 IQ,  74.

6. What to do if ...

Measurement is not carried out

Cause	Remedy
Temperature in the housing of the P 700 IQ outside the permitted operating temperature	See log book Automatic or manual measurement is only possible if the operating temperature in the housing is adhered to
Ambient temperature of the P 700 IQ outside the permitted operating temperature	Retrofitting with climate kit Checking the climate kit Checking the housing ventilator

Display “----”

Cause	Remedy
No (valid) measured value available	Start measurement and wait for the measurement to be finished (5 .. 7 min)
Calibration error	Carry out calibration
Container for reagent empty	Check the liquids and connect a new set of liquids if necessary
Liquid container not correctly connected	Connect correctly
Sample intake does not work	Check the pump Switch on the pump Clean the overflow vessel
Power failure	Restart measurement in the calibration and service menu. Automatic start of measurement
Temperature in the housing of the P 700 IQ outside the permitted operating temperature	See log book Automatic or manual measurement is only possible if the operating temperature in the housing is adhered to
Unknown	See log book

Implausible measured values

Cause	Remedy
	Wait for another measurement
Calibration error	Carry out calibration
Measuring cell of the photometer unit dirty	Carry out cleaning procedure
Container for reagent RE 2.5 is empty	Exchange RE 2.5
Interferences, e.g. in sample matrix	Select suitable measuring location
A valve does not operate	Perform a <i>Hydraulic check</i> Contact the service department
Photometer unit draws air (e.g. lack of sample in the overflow vessel)	Make sure that there is enough sample in the overflow vessel, e.g. Service the filter unit Set the pump output to 10 - 100 ml / min
Measured values too low after cleaning	Automatically remove residues of the cleaning solution in the hoses using the <i>Conditioning</i> function. After cleaning, a rinse is carried out for each of the set number of steps and then a rinse with the sample and the added reagent.

Display of OFL

Cause	Remedy
Measuring range exceeded	Select a different measuring range
Calibration error	Carry out calibration
Measuring cell dirty	Carry out a cleaning procedure

Display of ERROR

Cause	Remedy
P700IQ-PO4 not correctly connected	Check the assignment of the terminal connections
Load on a power supply module too high	Install an additional power supply module (MIQ/PS) in the vicinity of the sensor
IQ SENSOR NET cable to the P 700 IQ too long (voltage drop too great)	Install an additional power supply module (MIQ/PS) in the vicinity of the sensor
Electrical connection between the power supply module and the P 700 IQ is interrupted	Starting with the power supply module (MIQ/PS), check the cable connection step by step and replace defective cable sections Check the contacts on the MIQ modules (stack mounting). Clean any dirty contacts. Carefully bend back contact springs that have been pressed flat or bent (pay attention to sufficient spring tension)
External electrical power supply disrupted	Check the power supply, check the maximum load

Measuring mode cannot be set

Cause	Remedy
The P 700 IQ is not stopped	Stop the P 700 IQ (see section 5.3.2,  69).

7. Technical data

7.1 Measurement characteristics

Measuring method

Vanadate molybdate method (yellow method) in combination with an LED photometer

Measuring ranges and resolutions

Measuring mode (citation form)	Measuring ranges	Resolution	Accuracy
<i>PO₄-P</i>	A: 0.05 .. 15.00 mg/L B: 1 ... 50 mg/L	0.01 1	±2 %, ±0.05 ±2 %, ±1
	A: 0.05 ... 15.00 ppm B: 1 ... 50 ppm	0.01 1	±2 %, ±0.05 ±2 %, ±1
<i>PO₄</i>	A: 0,15 .. 46,00 mg/L B: 3 ... 153 mg/L	0.01 1	±2 %, ±0.15 ±2 %, ±3
	A: 0.15 ... 46.00 ppm B: 3 ... 153 ppm	0.01 1	±2 %, ±0.15 ±2 %, ±3

All specifications concerning the measuring accuracy refer to the use of suitable standard solutions.

7.2 Application characteristics

Suitability and areas of application

The P 700 IQ analyzer is designed for online measurements of the orthophosphate concentration (PO₄) in aqueous samples, especially for phosphorus elimination in wastewater treatment plants.

Measuring medium

Temperature	4 ... 45 °C
pH value	5 ... 9
Solids contents	< 6 g/l

7.3 General data

Dimensions and weight

Component	Height x width x depth	Weight (without chemicals)
Housing with components	825 x 686 x 438 mm	up to approx. 37 kg (depending on equipment)

Front view:

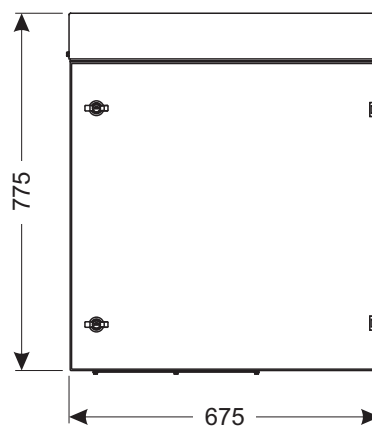

Lateral view:

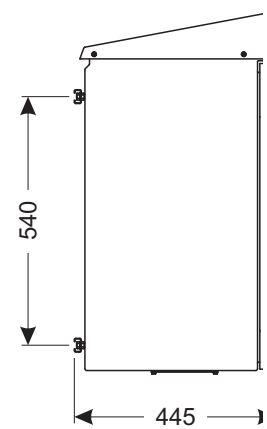

Required space

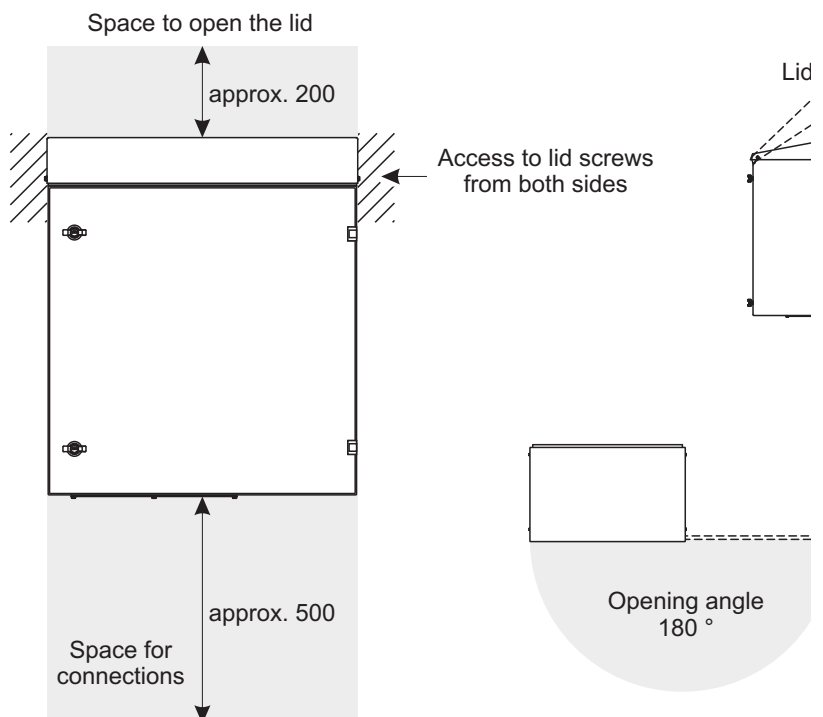

Fig. 7-1: Dimension drawing of P 700 IQ housing (dimensions in mm)

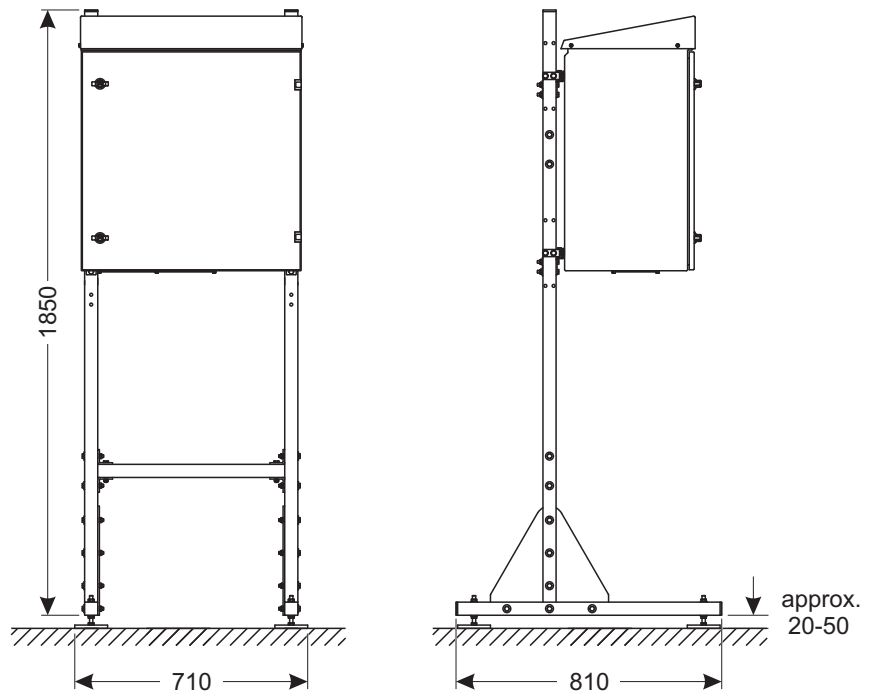

Fig. 7-2: Dimension drawing of P 700 IQ, installation on a mounting stand (dimensions in mm)

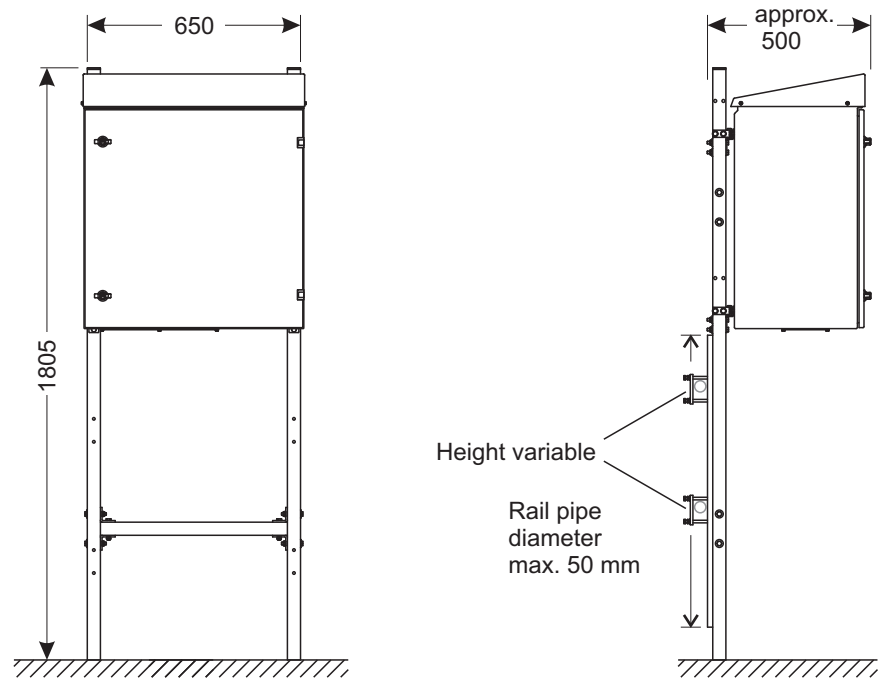

Fig. 7-3: Dimension drawing of P 700 IQ, rail mounting (dimensions in mm)

Connection technique

Connection to the IQ SENSOR NET with the IQ SENSOR NET cable

Ambient conditions

Temperature range <ul style="list-style-type: none"> • Operation with climate kit without climate kit <ul style="list-style-type: none"> • Storage 	- 20 ... +40 °C (- 4 ... + 104 °F) + 15 ... +40 °C (+ 59 ... + 104 °F) -20 ... +50 °C (-4 ... +122 °F) (in completely empty condition)
Relative air humidity	Max. 95 % (non-condensing)
Site altitude	Max. 2000 m above sea level
Chloride concentration	< 500 mg/l (no seawater)

Components

Housing	Sunlight (UV) resistant Material: Powder-coated aluminum Mounting plate: PVC
Climate control (option)	Heating, ventilation
Peristaltic pump (photometer unit)	MasterFlex pump head 3 rolls 0.21 ml/rotation Norprene® pump tube, inner diameter 1.6 mm, length 21 cm
Mounting stand, wall fixture and rail fixture	Rails: stainless steel V2A, Screws etc.: stainless steel V2A, V4A

Light source for photometer	LED, 420 nm (violet)
Filtration unit	<p>Membrane surface: 1000 cm²</p> <p>Cut-off limit: < 0.45 µm</p> <p>Max. operating temperature: 45 °C (113 °F)</p> <p>Max. suction height: 5 m</p> <p>pH value: 2... 11.5</p> <p>Housing: PVC</p> <p>Seals: NBR</p> <p>Membrane: PVDF membrane, porous, glued to polyester fleece on both sides</p> <p>Sleeve tube: PVC-reinforced PCV tube, transparent, 24 x 3 mm</p> <p>Intake tube: PE 4 x 1 mm</p> <p>Tube length (inlet and outlet tube): Max. 20 m</p>
Overflow vessel	<p>Material: PVC</p> <p>Required sample quantity: 10 ... 100 ml/min</p> <p>For correct measurements, enough sample must always be available in the overflow vessel.</p>

Instrument safety

Applicable norms	<p>EN 61010-1</p> <p>UL 61010-1</p> <p>CAN/CSA C22.2#61010-1</p>
Electromagnetic compatibility	<p>EN 61326-1, EN 61326-2-3, FCC 47 CFR Part 15</p>
Type of protection (housing)	IP 54 (EN 60529)
Protective class	I
Overvoltage category	II

Test certificates

230 V AC	CE
115 V AC	CE, cETLus

7.4 Electrical data

Input voltage	Depending on the selected variant: 230 V AC, 50 Hz or 115 V AC $\pm 10\%$ / 60 Hz
Fuse protection of the building	16 A with ground fault circuit interrupter
Power consumption	35 - 1100 W depending on the option
<ul style="list-style-type: none"> • Basic consumption • Filtration pump • Climate kit • Heat tracing of the intake tube • Heat tracing of the return tube 	<p>35 W</p> <p>40 W</p> <p>200 W</p> <p>20 W/m (max. 20 m allowed)</p> <p>20 W/m (max. 20 m allowed)</p>

IQ SENSOR NET cable (SNCIQ, SNCIQ/UG, SACIQ)	<ul style="list-style-type: none"> • Isolation ≥ 500 V • Temperature-resistant in a range of -20 °C...$+80$ °C, • weather-resistant (year-round) • watertight (cable sheath)
Requirements on the: Power supply	<p>Nominal voltage: 230 V AC $\pm 10\%$ / 50 Hz or 115 V AC $\pm 10\%$ / 60 Hz</p> <p>Power supply: 3-pin, N/L /PE</p> <p>Cable cross-section of power supply: Europe: 1.5 ... 4.0 mm² USA: AWG 14 ... 12</p> <p>Fuse protection on the operator side: 16 A maximum</p> <p>Cable:</p> <ul style="list-style-type: none"> • Temperature-resistant in a range of -20 °C...$+80$ °C, • weather-resistant (year-round) • watertight (cable sheath)
Power consumption MIQ/WCA 232	0.5 W

7.5 Consumption data

The consumption of chemicals depends on the specified intervals and on the selected measuring range.

Typical consumption values

Solution	Sufficient for
Reagent solution RE 2.5	4 months (measuring range A, measuring interval 5 minutes) 4 months (measuring range B, measuring interval 10 minutes)
Cleaning solution CL 1.0	4 months (daily cleaning)
Standard solution ST	4 months (daily calibration)

8. Indexes

8.1 Explanation of the messages

This chapter contains a list of all message codes and the related message texts that can occur in the log book of the IQ SENSOR NET system for the P 700 IQ analyzer.



Information on the contents and structure of the log book and the structure of the message code is given in the LOG BOOK chapter of the IQ SENSOR NET system operating manual.

The last three digits of the message code form the component code. It identifies the component (active component) that caused the message:

Some error messages contain an internal error code, starting with "#".

Module code	Component
3Bx	P700IQ-PO4
55x	MIQ/WCA 232

8.1.1 Error messages

Message code	Message text
EA13Bx	<i>Meas. range exceeded or undercut</i> * <i>Check process</i> * <i>Select other meas. range</i>
EA43Bx	<i>Analyzer leakage</i> * <i>Check the tube connections</i>
EA53Bx	<i>Physical measurement range exceeded</i> * <i>Check the process</i>
EA63Bx	<i>Missing sample / Air bubbles in the analyzer</i> * <i>Check the tube connections</i> * <i>Check sample flow and fuel levels</i> * <i>Check the process</i>

Message code	Message text
EC13Bx	<p><i>Automatic calibration error: Calibration standard could not be determined or is not suitable for current measurement range. System stopped!</i></p> <ul style="list-style-type: none"> * Check the current measurement range * Check the used calibration standard
ES13Bx	<p><i>Component hardware defective</i></p> <ul style="list-style-type: none"> * Contact service
IC13Bx	<p><i>Factory calibration has been activated. Make sure the P700IQ-PO4 operates correctly.</i></p>
IC53Bx	<p><i>P700IQ-PO4 was successfully calibrated</i></p> <ul style="list-style-type: none"> * For calibration data, see calibration history
II13Bx	<p><i>Language not available, Default language German</i></p> <ul style="list-style-type: none"> * Contact service
IC63Bx	<p><i>Liquid tank xxx almost depleted!</i></p> <ul style="list-style-type: none"> * Please refill to maintain proper functioning
EI155x	<p><i>Operational voltage too low</i></p> <ul style="list-style-type: none"> * Check installation and cable lengths, Follow installation instructions * Power supply module(s) overloaded, add power supply module(s) * Check terminal and module connections * Defective components, replace components
EI255x	<p><i>Operational voltage too low, no operation possible</i></p> <ul style="list-style-type: none"> * Check installation and cable lengths, Follow installation instructions * Power supply module(s) overloaded, add power supply module(s) * Check terminal and module connections * Defective components, replace components
II155x	<p><i>Language not available, Default language German</i></p> <ul style="list-style-type: none"> * Contact service
ES255x	<p><i>Component hardware defective</i></p> <ul style="list-style-type: none"> * Contact service
EIA55x	<p><i>Communication between MIQ/WCA and P700IQ-PO4 disturbed</i></p> <ul style="list-style-type: none"> * Check cable connections * Provide voltage supply to P700IQ-PO4 * Contact service
EA755x	<p><i>Operating temperature too high!</i></p> <ul style="list-style-type: none"> * Check process and application
EA855x	<p><i>Operating temperature too low!</i></p> <ul style="list-style-type: none"> * Check process and application

8.1.2 Info messages

The analyzer does not generate any info messages.

8.2 Status info

The status info is a coded piece of information on the current status of a sensor. Each sensor sends this status info to the controller. The status info of sensors consists of 32 bits, each of which can have the value 0 or 1.

Status info, general structure

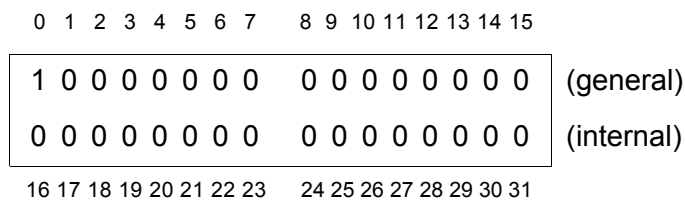

The bits 0 - 15 are reserved for general information.
The bits 16 - 21 are reserved for internal service information.

You obtain the status info:

- via a manual query in the *Einstellungen/Setup/Service/Liste aller Teilnehmer* menu (see system operating manual)
- by an automated query
 - from a superordinate process control (e.g. when connected to the Profibus)
 - from the IQ Data Server (see IQ SENSOR NET Software Pack operating manual)

The evaluation of the status info, e.g. in the case of an automated query, has to be made individually for each bit.

Status info P 700 IQ

Status bit	Explanation
Bit 0	<i>Component hardware defective</i>
Bit 1	<i>Liquid tank xxx almost depleted!</i>
Bit 2	<i>Missing sample / Air bubbles in the analyzer</i>
Bit 3	<i>Operating temperature too high!</i>
Bit 4	<i>Operating temperature too low!</i>
Bit 5	<i>Reserved</i>
Bit 6-31	-

9. Appendix

9.1 Glossary

Absorbance	Logarithmic measure for the absorption of the sample; negative decadic logarithm of the transmission.
Adjusting	To manipulate a measuring system so that the relevant value (e. g. the displayed value) differs as little as possible from the correct value or a value that is regarded as correct, or that the difference remains within the tolerance.
Blank value	The blank value is the measured value of a measuring system if the measured parameter has the value zero or is nonexistent. The blank value has to be determined and subtracted from the measured values of the actual samples.
Calibration	Comparing the value from a measuring system (e. g. the displayed value) to the correct value or a value that is regarded as correct. Often, this expression is also used when the measuring system is adjusted at the same time. See «Adjusting».
Citation forms	Different display formats that can be derived from each other of the measured value for a concentration. The method for determining phosphate provides, for example, a measured value for phosphorous P. This measured value can also be quoted in other citation forms such as PO ₄ , PO ₄ -P or P ₂ O ₅ .
Concentration	Mass or amount of a dissolved substance per volume, e. g. in g/L or mol/L.
Deionized water	Water that was freed of minerals with the aid of an ion exchanger. Deionized water may still contain uncharged contamination such as organic compounds. It is also called DI water.
Eutrophication	The excessive pollution of water bodies with nutrients is called eutrophication or overfertilization. To fight against the eutrophication of a water body, the phosphate load has to be reduced first of all. When the phosphate supply is limited, the nitrate contents cannot be consumed by plants even if they are available in huge quantities.

Firmware	The software permanently assigned to an instrument.
Ground fault circuit interrupter	Earth leakage circuit breaker. An electrical assembly group that switches off a circuit as soon as the strength of current in the phases does not exactly agree with the strength of current in the neutral conductor. The current difference can be caused by a grounded person inadvertently touching a live part of the circuit.
LED	Light emitting diode.
Measured parameter	The measured parameter is the physical dimension determined by measuring, e. g. pH, conductivity or D.O. concentration.
Measured value	The special value to be determined of a measured parameter. It is given as a combination of the numerical value and unit (e. g. 3 m; 0.5 s; 5.2 A; 373.15 K).
Measuring system	A measuring system comprises all the devices used for measuring, e. g. meter and sensor. In addition, there is the cable and possibly an amplifier, terminal box and armature.
MSDS	Safety datasheets (Material Safety Data Sheets). Usually, the chemicals manufacturers provide safety datasheet with the chemicals delivered. The safety datasheets provide security relevant information on the substances delivered. MSDS can also be found on the Internet.
Operator	Legal designation for the owner of the system. The operator is responsible for the installed system, especially for the safety and training of the staff.
pH value	A measure of the acidic or basic effect of an aqueous solution. It corresponds to the negative decadic logarithm of the molal hydrogen ions activity divided by the unit of the molality. The practical pH value is the value of a pH measurement.
PPE	Personal protective equipment. The PPE includes clothing and other equipment that is used to protect you against risks at your place of work. You must always wear your PPE while doing dangerous jobs to avoid injuries or damage to your health. Typical examples are gloves, protective goggles, face protection shield, breathing protection, ear protection, safety helmet, safety shoes, fall protection. The PPE must fulfill the national standards and laws.
Reset	Restoring the original condition of all settings of a measuring system.

Resistance	Short name for the electrolytic resistivity. It corresponds to the reciprocal value of the electrical conductivity.
Resolution	Smallest difference between two measured values that can be displayed by a meter.
Slope	The slope of a linear calibration function.
Standard solution	A solution whose measured value is known per definition. It is used to calibrate a measuring system.
Test sample	Designation of the test sample ready to be measured. Normally, a test sample is made by processing the original sample. The test sample and original sample are identical if the test sample was not processed.
Transmission	The part of the light that goes through the sample.

What can Xylem do for you?

We're a global team unified in a common purpose: creating innovative solutions to meet our world's water needs. Developing new technologies that will improve the way water is used, conserved, and re-used in the future is central to our work. We move, treat, analyze, and return water to the environment, and we help people use water efficiently, in their homes, buildings, factories and farms. In more than 150 countries, we have strong, long-standing relationships with customers who know us for our powerful combination of leading product brands and applications expertise, backed by a legacy of innovation.

For more information on how Xylem can help you, go to xyleminc.com.



Service address:

Xylem Analytics Germany
Sales GmbH & Co. KG
WTW
Dr.-Karl-Slevogt-Str. 1
82362 Weilheim
Germany

Tel.: +49 881 183-325
Fax: +49 881 183-414
E-Mail wtw.rma@xyleminc.com
Internet: www.WTW.com



Xylem Analytics Germany GmbH
Dr.-Karl-Slevogt-Str. 1
82362 Weilheim
Germany